



INDEX / INDICE

GASKETS & GASKETS KITS / GUARNIZIONI E KIT GUARNIZIONI

OUTBOARD / FUORIBORDO

■	CHRYSLER FORCE	4
	JOHNSON / EVINRUDE (OMC)	10
	MERCURY	22
	NISSAN-TOHATSU 	42
	YAMAHA	44

INBOARD / ENTROBORDO

■	MERCUISER / GM	59
	VOLVO PENTA	64
	YANMAR	65

PERSONAL WATER CRAFT / MOTO D'ACQUA

■	KAWASAKY	71
	POLARIS	79
	SEA-DOO	82
	TIGER SHARK 	87
	YAMAHA	89

OEM CROSS REFERENCE LIST / LISTA CODICI ORIGINALI - CODICI ATHENA

■	ATHENA # - OEM# - PAG. #	97
	OEM # - ATHENA # - PAG. #	106

APPLICATIONS APPLICAZIONI	YEAR ANNO	SPECIFICATION SPECIFICHE	CYLINDERS CILINDRI	POWER HEAD GASKET KIT KIT G.NI MOTORE	HEAD GASKET G.NE TESTA CILINDRO	BASE GASKET G.NE BASE CILINDRO	NOTE
40 HP	1981-1987, 1988	A Models	2	P600334850013	S610334001014	S610334006007	
40 HP	1988	B, C, D Models	2	P600334850019	S610334001014	S610334006009	
40 HP	1989-1994	A, B, C, D Models	2	P600334850020	S610334001013	S610334006009	
40 HP	1995-99	A, B, C, D Models	2	P600334850021	S610334001013	S610334006006	
45 HP	1974-1983		2	P600334850013	S610334001014	S610334006007	
45 HP	1988	B, C, D Models	2	P600334850019	S610334001014	S610334006009	
45 HP	1989-1994	A, B, C, D Models	2	P600334850020	S610334001013	S610334006009	
45 HP	1995-99	A, B, C, D Models	2	P600334850021	S610334001013	S610334006006	
50 HP	1981-1987	1988 A Models	2	P600334850013	S610334001014	S610334006007	
50 HP	1988	B, C, D Models	2	P600334850019	S610334001014	S610334006009	
50 HP	1989-1994	A, B, C, D Models	2	P600334850020	S610334001013	S610334006009	
50 HP	1995-99	A, B, C, D Models	2	P600334850021	S610334001013	S610334006006	
55 HP	1972-1976		2	P600334850013	S610334001014	S610334006007	
70 HP	1970-1973		3	P600334850002	S610334001001	S610334006001	
70 HP	1979-1980		3	P600334850002	S610334001001	S610334006001	
70 HP	1991-95	Single Carb	3	P600334850022	S610334001001	S610334006001 S610334006027 S610334006001	
70 HP	1999		3	P600334850023	S610334001001	S610334006005 S610334006008	
75 HP	1974-1984		3	P600334850002	S610334001001	S610334006001 S610334012009	
75 HP	1996-98	Single Carb	3	P600334850022	S610334001001	S610334006001 S610334006027	
75 HP	1999		3	P600334850024	S610334001001	S610334006001 S610334012009	
85 HP	1970-1973		3	P600334850002	S610334001001	S610334006001	
85 HP	1977-1979		3	P600334850002	S610334001001	S610334006001	
85 HP	1980-1989		3	P600334850002	S610334001001	S610334006001	
90 HP	1974-1977		3	P600334850002	S610334001001	S610334006001	
90 HP	1983, 1989-1990		3	P600334850002	S610334001001	S610334006001	
90 HP	1991-1994		3	P600334850024	S610334001001	S610334006001 S610334012009	
90 HP	1995-1999		3	P600334850023	S610334001001	S610334006001 S610334006005 S610334006008	
90 HP	1993-1996	Sport Jet	3	P600334850025	S610334001001	S610334012009	
95 HP	1993-1996	Sport Jet	3	P600334850025	S610334001001	S610334012009	
100 HP	1979-1981		4	P600334850003	S610334001002	S610334006001	
100 HP	1983-1984		4	P600334850003	S610334001002	S610334006001	
105 HP	1972-1978		4	P600334850003	S610334001002	S610334006001	
105 HP	1982		4	P600334850003	S610334001002	S610334006001	
105 HP	1979-1983		4	P600334850003	S610334001002	S610334006001	
115 HP	1977-1983		4	P600334850003	S610334001002	S610334006001	
120 HP	1971-1977		4	P600334850003	S610334001002	S610334006001	

APPLICATIONS APPLICAZIONI	YEAR ANNO	SPECIFICATION SPECIFICHE	CYLINDERS CILINDRI	POWER HEAD GASKET KIT KIT G.NI MOTORE	HEAD GASKET G.NE TESTA CILINDRO	BASE GASKET G.NE BASE CILINDRO	NOTE
120 HP	1989-1994		4	P600334850003	S610334001002	S610334006001	
120 HP	1995-1999		4	P600334850026	S610334001002	S610334006001 S610334006005 S610334006008	
120 HP	1996-2000	Sport Jet	4	P600334850027	S610334001002	S610334012009	
125 HP	1983-1988 Later		4	P600334850003	S610334001002	S610334006001	1988A&B Models
130 HP	1972		4	P600334850003	S610334001002	S610334006001	
135 HP	1974-1977		4	P600334850003	S610334001002	S610334006001	
140 HP	1978-1983		4	P600334850003	S610334001002	S610334006001	

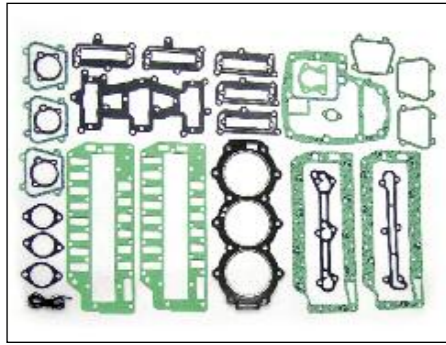

P600334850002
27-809748A1

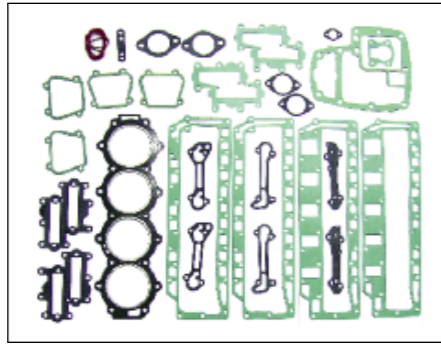

P600334850003
27-809754A1

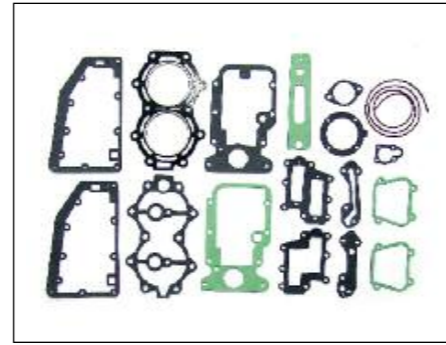

P600334850013
27-809755A1

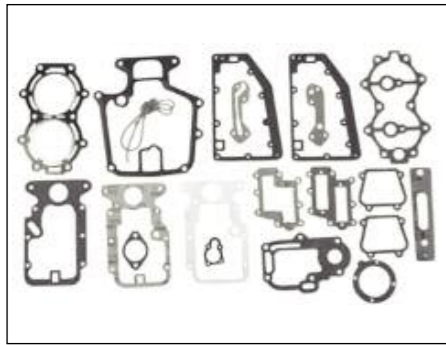

P600334850019
27-809751A1

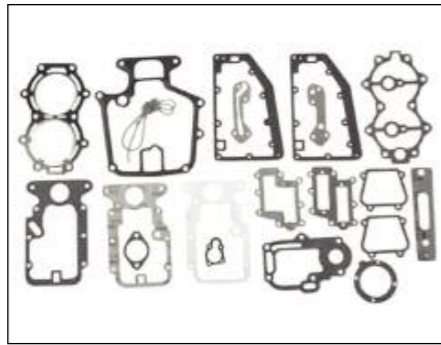

P600334850020
27-809746A1

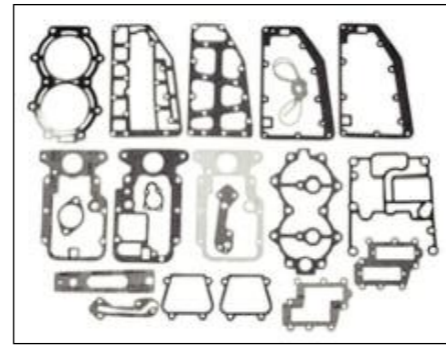

P600334850021
27-820751A2

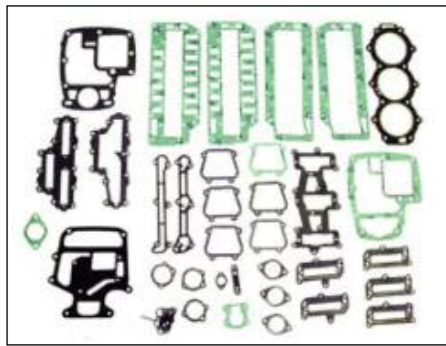

P600334850022
27-820724A2

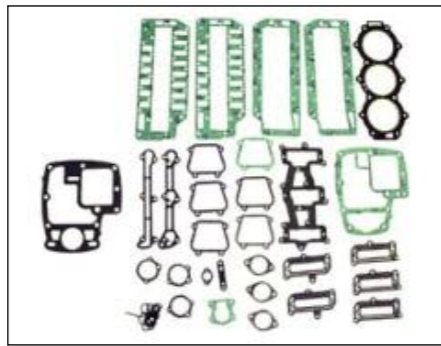

P600334850023
27-809122A2

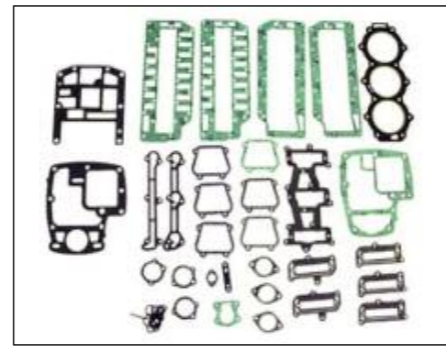

P600334850024
27-820725A1
27-809748A1



P600334850025
27-82059A1
27-809469A2

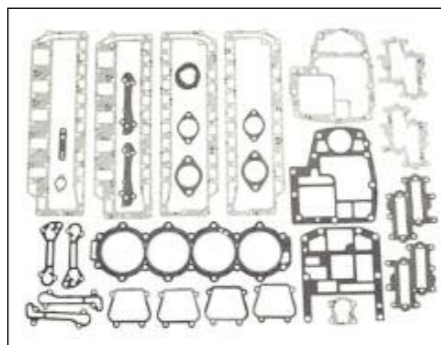

P600334850026
27-809125A2

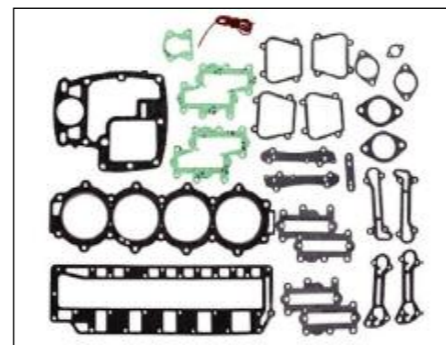

P600334850027
27-809817A1



S610334001001
27-820438



S610334001002
27-F476529-4
27-824615

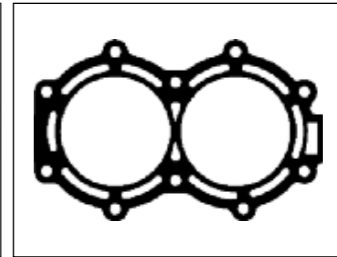

S610334001013
27-691529-1



S610334001014
27-F658529



S610334006001
27-819381

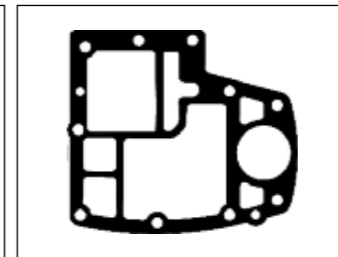

S610334006005
27-826549

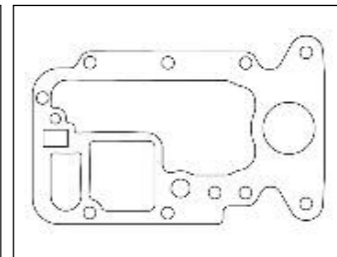

S610334006006
27-82687-1

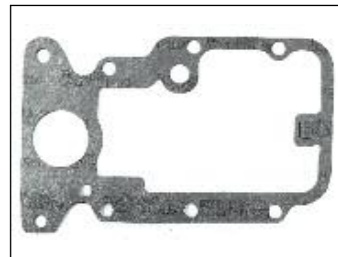

S610334006007
27-F307279-2

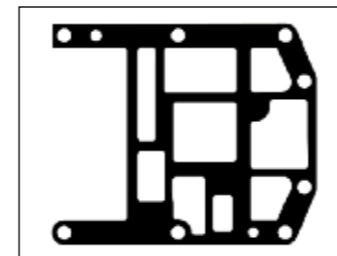

S610334006008
N.A.

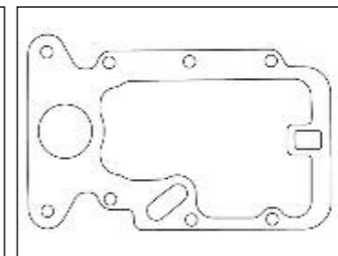

S610334006009
N.A.



S610334006026
27-F684453-1



S610334006027
27-819049-3

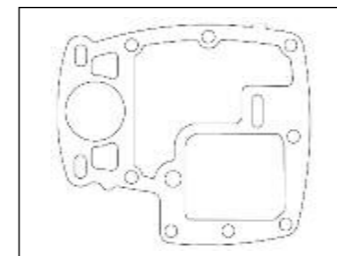

S610334012009
27-819381-4

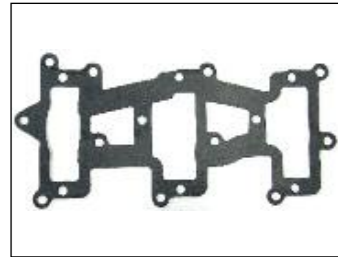

S610334010002
INTAKE GASKET
27-F85159-1



S610334010003
INTAKE GASKET
27-F406406

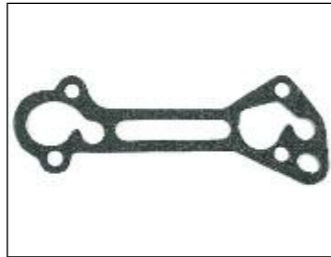

S610334010004
INTAKE GASKET
27-F84748-3



S610334010005
INTAKE GASKET
N.A.

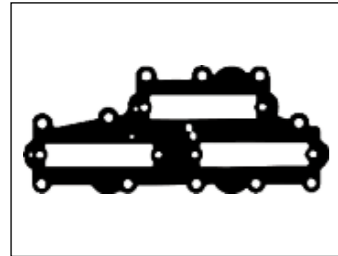

S610334010012
CARB. INTAKE GASKET
27-819113

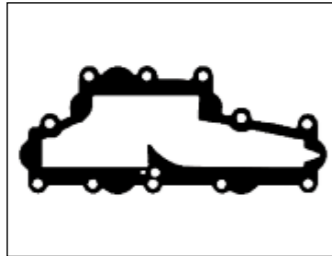

S610334010014
INTAKE MANIFOLD GASKET
27-819114-1



S610334010015
REEDGASKET
N.A.



S610334010016
CYLINDER INTAKE GASKET

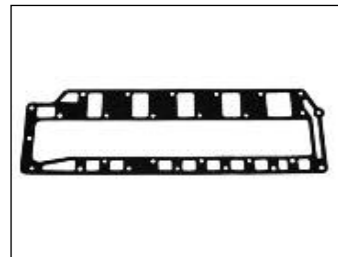

S610334012028
EXHAUST GASKET
N.A.

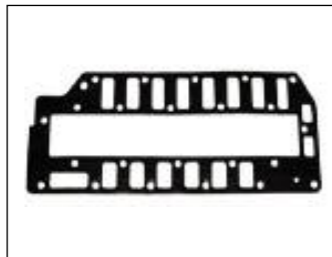

S610334012029
EXHAUST GASKET
27-819023 1

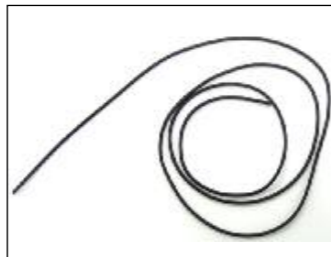

S610334015001
GASKET SIL. 60sh D.2,2
N.A.



S610334015002
SILICON GASKET
N.A.

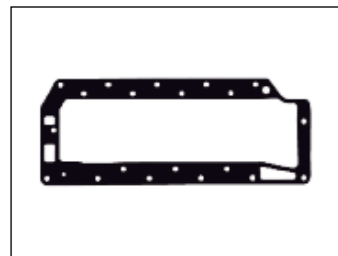

S610334021003
COVER GASKET
27-F85154-1

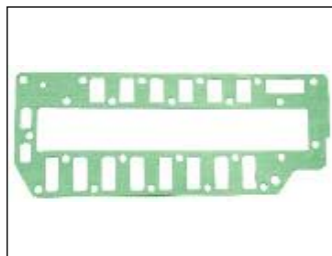

S610334021004
COVER GASKET
27-F85154-4

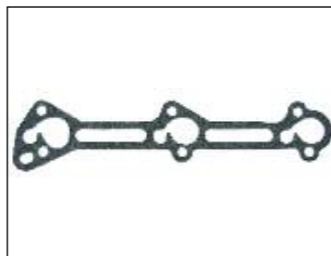

S610334021005
COVER GASKET
27-F85748-2



S610334021006
COVER GASKET
27-F85472-2

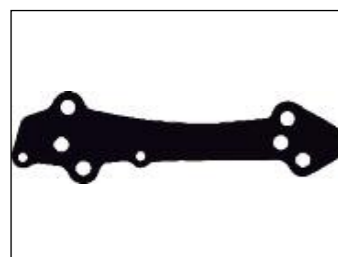

S610334021007
GENERATOR COVER GASKET
27-F686472

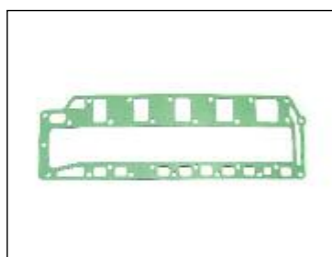

S610334021008
COVER GASKET
27-819024-2

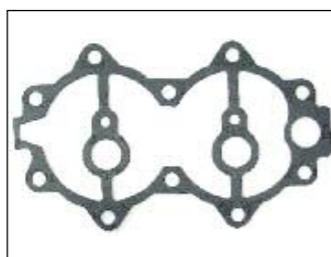

S610334021021
COVER GASKET
N.A.



S610334021029
THERMOSTAT COVER GASKET
27-F93472-1



S610334021030
CYLINDER DRAIN GASKET
N.A.



S610334021031
CARBURETOR GASKET
N.A.



S610334021032
COVER GASKET
27-F40154-4



S610334021033
CARBURETOR GASKET
27-F97067



S610334047005
PORT COVER GASKET
27-F40223

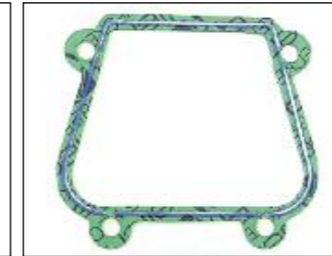

S610334047006
COVER GASKET
N.A.

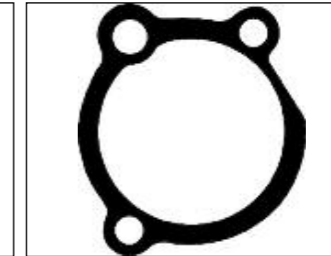

S610334047007
COVER GASKET
27-F481836

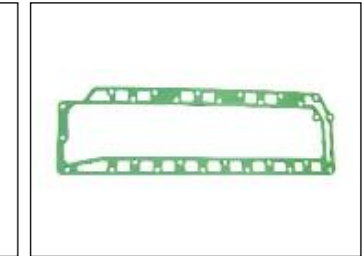

S610334047008
COVER GASKET
27-F372154-1



S610334047018
COVER GASKET
N.A.

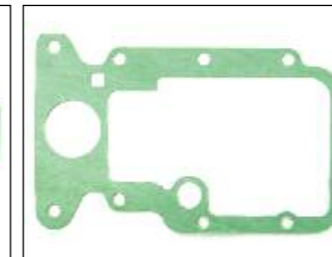

S610334047019
COVER GASKET
27-F40279-1

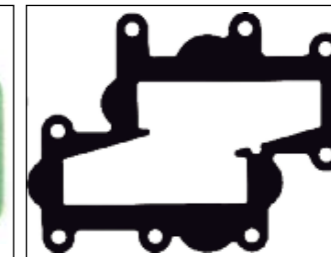

S610334093006
CARBURETOR GASKET
27-F178168-1



S610334108001
BY PASS GASKET
N.A.



S610334108002
FLANGE GASKET
27-F85762



S610334108003
FLANGE GASKET
N.A.



S610334108004
FLANGE GASKET 4 HOLE
N.A.

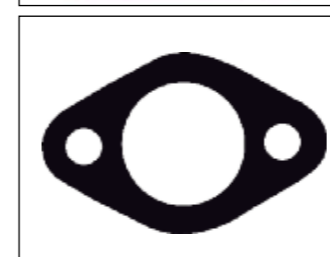

S610334108002
FLANGE GASKET
27-F85762

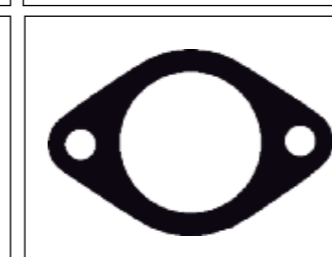

S610334108003
FLANGE GASKET
N.A.



S610334108004
FLANGE GASKET 4 HOLE
N.A.

APPLICATIONS APPLICAZIONI	YEAR ANNO	SPECIFICATION SPECIFICHE	CYL CIL	GASKET KIT KIT G.NI MOTORE	HEAD GASKET G.NE TESTA CILINDRO	BASE GASKET G.NE BASE CILINDRO	OIL SEAL KIT KIT PARAOLIO	NOTE
4 HP	All		4	-	S610245001017	-	-	
5 HP	1980-2001		2	-	S610245001019	-	-	
5.5 HP	1959-1979		2	-	S610245001020	-	-	
6 HP	1959-1979		2	-	S610245001020	-	-	
6 HP	1980-2001		2	-	S610245001019	-	-	
6.5 HP	1980-2001	Comm	2	-	S610245001019	-	-	
7.5 HP	1980-2001		2	-	S610245001019	-	-	
8 HP	1980-2001		2	-	S610245001019	-	-	
9.9 HP	1976-1992		2	P600245850013	S610245001013	S610245006008 S610245006009	-	
9.9 HP	1993-1999		2	P600245850020	S610245001021	S610245006008 S610245006009	-	
10 HP	1976-1992		2	P600245850013	S610245001013	S610245006008 S610245006009	-	
14 HP	1976-1992		2	P600245850013	S610245001013	S610245006008 S610245006009	-	
15 HP	1976-1992		2	P600245850013	S610245001013	S610245006008 S610245006009	-	
15 HP	1993-1999		2	P600245850020	S610245001021	S610245006008 S610245006009	-	
18 HP	1959-1973		2	-	S610245001023	-	-	
20 HP	1985-1997		2	P600245850012	S610245001010	S610245006002	P600245400012	
25 HP	1969-1976		2	-	S610245001023	-	-	
25 HP	1979-1984		2	P600245850012	S610245001010	S610245006002	P600245400012	
25 HP	1985-1997	Except D Model	2	P600245850012	S610245001010	S610245006002	P600245400012	
30 HP	1985-1997	Except D Model	2	P600245850012	S610245001010	S610245006002	P600245400012	
35 HP	1979-1984		2	P600245850012	S610245001010	S610245006002	P600245400012	
35 HP	1985-1997		2	P600245850012	S610245001010	S610245006002	P600245400012	
40 HP	1960-1980		2	-	S610245001018	-	-	
40 HP	1981-1990	Comm	2	P600245850021	S610245001018	-	-	
40 HP	1984-1997		2	P600245850003	S610245001003	S610245006003	P600245400003	
45 HP	1985-1992	Comm	2	P600245850003	S610245001003	S610245006003	P600245400003	
45 HP	1987-1990	SS	2	-	S610245001003	-	-	
48 HP	1987-1997		2	P600245850003	S610245001003	S610245006003	P600245400003	
50 HP	1971-1975		2	P600245850003	S610245001003	S610245006003	P600245400003	
50 HP	1979-1980		2	P600245850003	S610245001003	S610245006003	P600245400003	
50 HP	1981-1997		2	P600245850003	S610245001003	S610245006003	P600245400003	
55 HP	1977-1979		2	P600245850003	S610245001003	S610245006003	P600245400003	
55 HP	1980-1997		2	P600245850003	S610245001003	S610245006003	P600245400003	
60 HP	1970-1971		2	-	S610245001012	-	-	
60 HP	1980-1985		2	P600245850003	S610245001003	S610245006003	P600245400003	
60 HP	1986-1988		3	P600245850008	S610245001012	S610245006005	P600245400003	
60 HP	1989-1997		3	P600245850009	S610245001005	S610245006006	P600245850003	
65 HP	1972-1986		3	P600245850008	S610245001012	S610245006005	P600245400003	
65 HP	1987-1992		3	P600245850009	S610245001005	S610245001005	P600245850003	
70 HP	1974-1985		3	P600245850008	S610245001012	S610245006005	P600245400003	

APPLICATIONS APPLICAZIONI	YEAR ANNO	SPECIFICATION SPECIFICHE	CYL CIL	GASKET KIT KIT G.NI MOTORE	HEAD GASKET G.NE TESTA CILINDRO	BASE GASKET G.NE BASE CILINDRO	OIL SEAL KIT KIT PARAOLIO	NOTE
70 HP	1986-1997		3	P600245850009	S610245001005	S610245001005	P600245850003	
75 HP	1975-1989		3	P600245850008	S610245001012	S610245006005	P600245400003	
85 HP	1973-1978		4	P600245850022	-	S610245006010	-	WITHOUT HEAD GASKET
85 HP	1979-1995		4	P600245850001	S610245001001	S610245015001	P600245400001	
88 HP	1987-1992		4	P600245850001	S610245001001	S610245015001	P600245400001	
88 HP	1992-1996		4	P600245850001	S610245001001	S610245015001	P600245400001	
90 HP	1981-1991		4	P600245850001	S610245001001	S610245015001	P600245400001	
90 HP	1992-1997		4	P600245850001	S610245001001	S610245015001	P600245400001	
90 HP	1995-2000	60° V4	4	P600245850004	M752603375004	S610245012007	P600245400004	
90 HP		Ficht FFI	4	P600245850010	M752603375004	S610245012007	P600245400010	
100 HP	1979-1991		4	P600245850001	S610245001001	S610245015001	P600245400001	
100 HP	1992-UP		4	P600245850001	S610245001001	S610245015001	P600245400001	
110 HP	1986-1990		4	P600245850001	S610245001001	S610245015001	P600245400001	
115 HP	1973-1977		4	P600245850022	S610245001001	S610245006010	-	WITHOUT HEAD GASKET
115 HP	1978-1991		4	P600245850001	S610245001001	S610245015001	P600245400001	
115 HP	1992-1999		4	P600245850001	S610245001001	S610245015001	P600245400001	
115 HP	1995-2000	60° V4	4	P600245850004	M752603375004	S610245012007	P600245400004	
115 HP		Ficht FFI	4	P600245850010	M752603375004	S610245012007	P600245400010	
120 HP	1985-1987	SB	4	P600245850014	S610245001014	S610245006004	-	
120 HP	1988-1994	BB	4	P600245850006	S610334001003	S610245006004	P600245400006	
130 HP	1995-2000		4	P600245850006	S610334001003	S610245006004	P600245400006	
135 HP	1973-1976		4	P600245850022	S610245001001	S610245006010	-	WITHOUT HEAD GASKET
135 HP		Ficht FFI	4	P600245850010	M752603375004	S610245012007	P600245400010	
140 HP	1973-1976		4	P600245850022	S610245001001	S610245006010	-	WITHOUT HEAD GASKET
140 HP	1978-1984		4	P600245850001	S610245001001	S610245015001	P600245400001	
140 HP	1985-1987	SB	4	P600245850014	S610245001014	S610245006004	-	
140 HP	1988-1994	BB	4	P600245850006	S610334001003	S610245006004	P600245400006	
150 HP	1978-1992	Crossflow	6	P600245850002	S610245001002	S610245015002	P600245400002	
150 HP	1991-1992	60°	6	P600245850005	M752603375004	S610245012007	P600245400004	
150 HP	1991-2000	60°	6	P600245850005	M752603375004	S610245012007	P600245400004	
150 HP		Ficht FFI	6	P600245850007	M752603375004	S610245012006	P600245400007	
155 HP	1978-1992	Crossflow	6	P600245850002	S610245001002	S610245015002	P600245400002	
175 HP	1977-1983	SB	6	P600245850002	S610245001002	S610245015002	P600245400002	
175 HP	1986-1991	BB	6	P600245850015	S610245001016	S610245015002	-	
175 HP	1991	60°	6	P600245850005	M752603375004	S610245012007	P600245400004	
175 HP	1992-2000	60°	6	P600245850005	M752603375004	S610245012007	P600245400004	
175 HP		Ficht FFI	6	P600245850007	M752603375004	S610245012006	P600245400007	
185 HP	1984-1985		6	P600245850002	S610245001002	S610245015002	P600245400002	
200 HP	1976-1983	SB	6	P600245850002	S610245001002	S610245015002	P600245400002	
200 HP	1985-1987	SB	6	P600245850023	S610245001015	S610245006007	-	
200 HP	1988-1992	BB	6	P600245850011	S610245001007	S610245006007	P600245400006	
200 HP	1993-UP	BB	6	P600245850024	S610334001008	S610245006011	-	
200 HP	1999-2001	Ficht FFI	6	P600245850025	S610245001011	S610245006011	-	
225 HP	1985-1987	SB	6	P600245850023	S610245001015	S610245006007	-	
225 HP	1988-1992	BB	6	P600245850011	S610245001007	S610245006007	P600245400006	
225 HP	1993-UP	BB	6	P600245850024	S610334001008	S610245006011	-	

JHONSON EUNIRUDE
CUSTOMER SERVICE - SERVIZIO CLIENTI: info@athena-ad.com

JHONSON EUNIRUDE
CUSTOMER SERVICE - SERVIZIO CLIENTI: info@athena-ad.com

APPLICATIONS APPLICAZIONI	YEAR ANNO	SPECIFICATION SPECIFICHE	CYL CIL	GASKET KIT KIT G.NI MOTORE	HEAD GASKET G.NE TESTA CILINDRO	BASE GASKET G.NE BASE CILINDRO	OIL SEAL KIT KIT PARAOLIO	NOTE
225 HP	1999-UP	Ficht FFI	6	P600245850024	S610334001008	S610245006011	-	
225 HP	2000-2004		6	P600245850025	S610245001011	S610245006011	-	
235 HP	1978-1979	SB X-flow	6	P600245850002	S610245001002	S610245015002	P600245400002	MUST ADD PART NUMBER S610245012008 AND S610245012013
235 HP	1980-1985	BB	6	P600245850015	S610245001016	S610245015002	-	
250 HP	2000	Carb Only	6	P600245850024	S610334001008	S610245006011	-	
250 HP	2000-2004		6	P600245850025	S610245001011	S610245006011	-	
250 HP	1990-1993	BB	8	P600245850026	S610245001009	S610245006001	-	
275 HP	1985-1987	SB	8	P600245850027	S610245001022	S610245006001	-	
300 HP	1985-1987	SB	8	P600245850027	S610245001022	S610245006001	-	
300 HP	1990-1993	BB	8	P600245850026	S610245001009	S610245006001	-	
1.6 L	1983-1990		4	P600245850001	S610245001001	S610245015001	P600245400001	
1.8 L	1987		4	P600245850014	S610245001014	S610245006004	-	
2.0 L	1988-1990		4	P600245850006	S610334001003	S610245006004	P600245400006	
2.5 L	1982-1985		6	P600245850002	S610245001002	S610245015002	P600245400002	
2.6 L	1982-1986	X-flow	6	P600245850015	S610245001016	S610245015002	-	
2.7 L	1987		6	P600245850023	S610245001015	S610245006007	-	
3.0 L	1988-1990		6	P600245850011	S610245001007	S610245006007	P600245400006	
3.3 L	2000-2004		6	P600245850025	S610245001011	S610245006011	-	
3.6 L	1985-1987	SB Loop	8	P600245850027	S610245001022	S610245006001	-	
4.0 L	1990-1997	BB Loop	8	P600245850026	S610245001009	S610245006001	-	

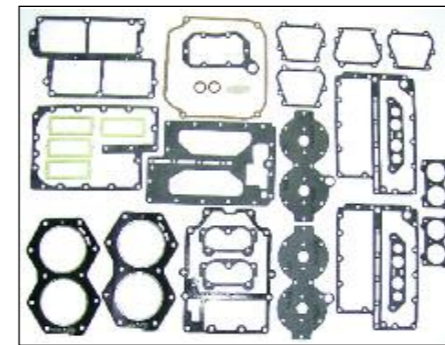

P600245850001
439085

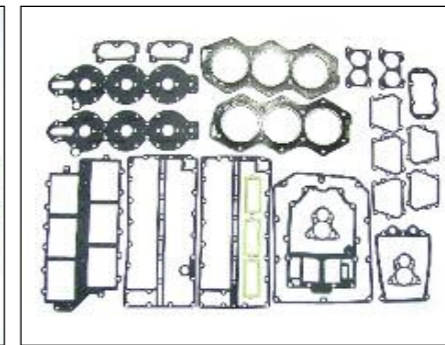

P600245850002
391988

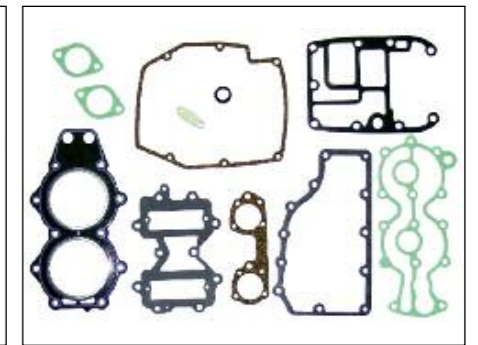

P600245850003
393433

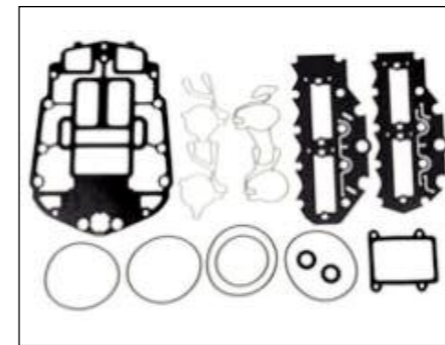

P600245850004
437779

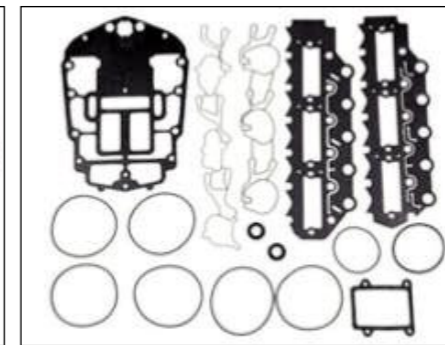

P600245850005
437155

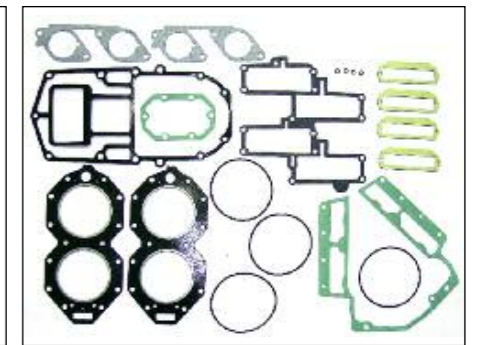

P600245850006
432570

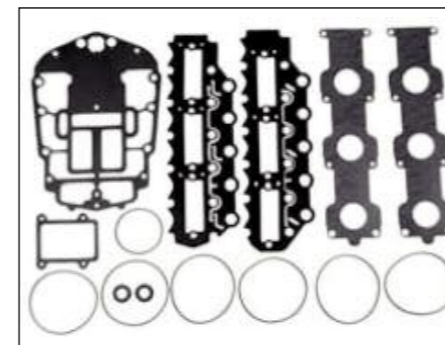

P600245850007
439202

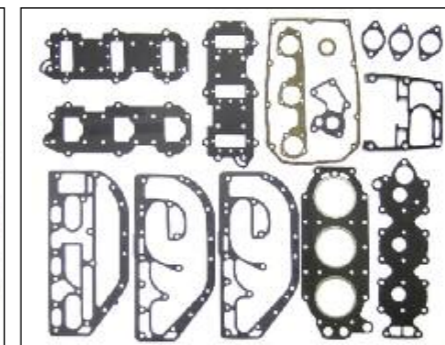

P600245850008
390078

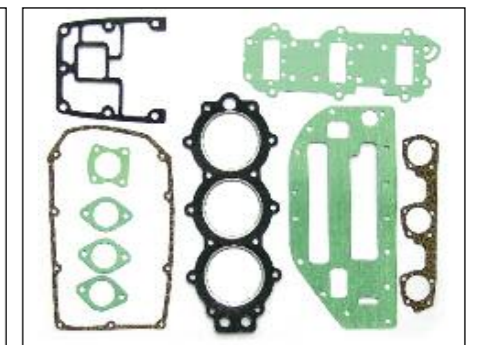

P600245850009
398047

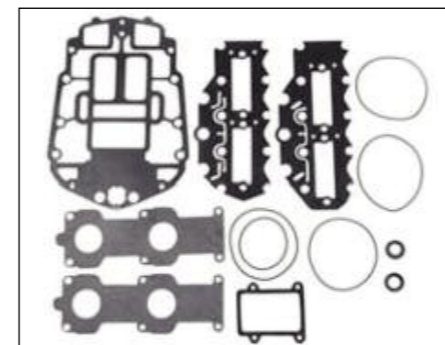

P600245850010
5000400

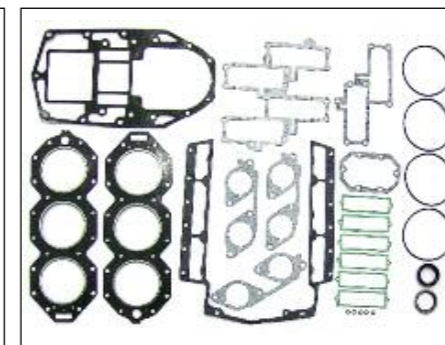

P600245850011
436891



P600245850012
392615

JHONSON EWINRUDE

JHONSON EWINRUDE

CUSTOMER SERVICE - SERVIZIO CLIENTI: info@athena-ad.com

CUSTOMER SERVICE - SERVIZIO CLIENTI: info@athena-ad.com

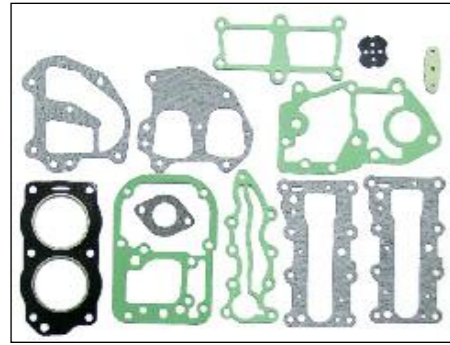

P600245850013
394546

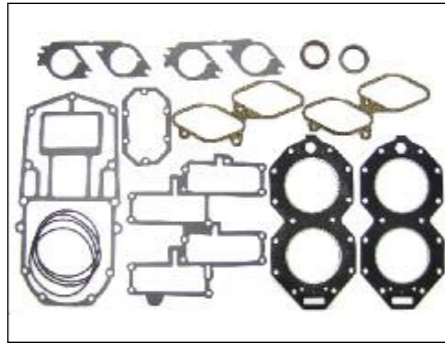

P600245850014
396750

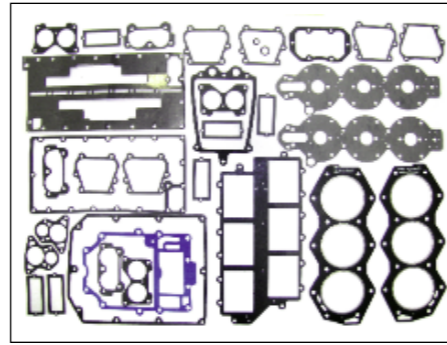

P600245850015
434381

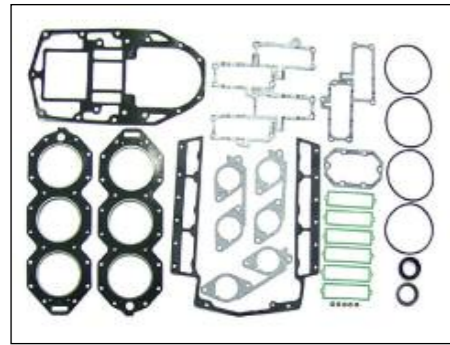

P600245850019
436891

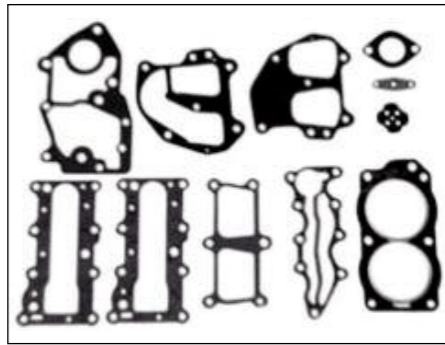

P600245850020
N.A.

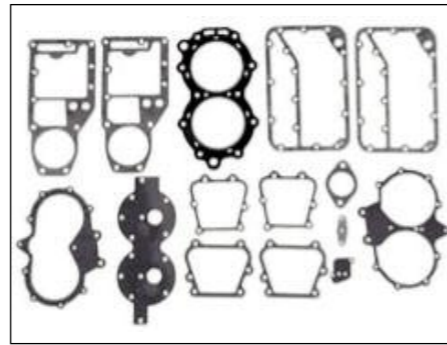

P600245850021
390700

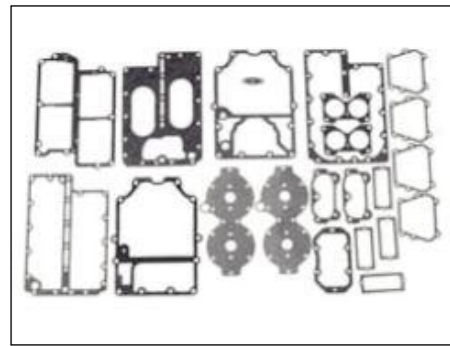

P600245850022
388602

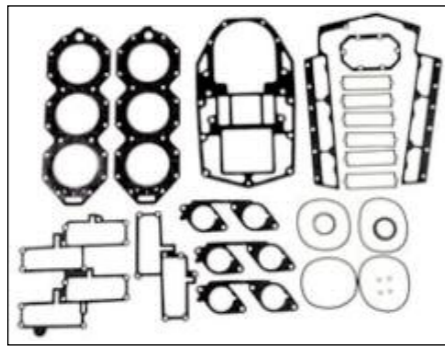

P600245850023
398172

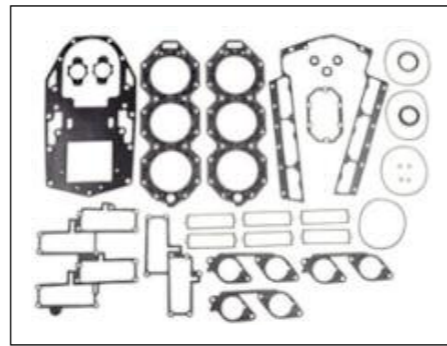

P600245850024
437725

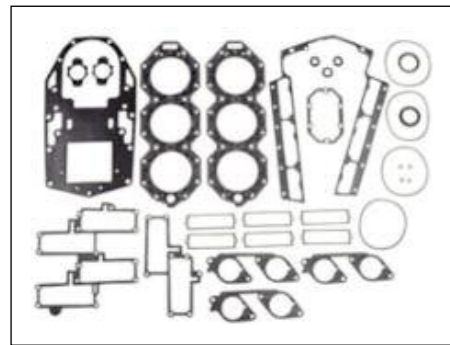

P600245850025
N.A.

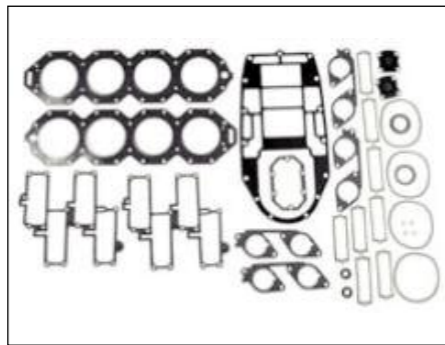

P600245850026
398693

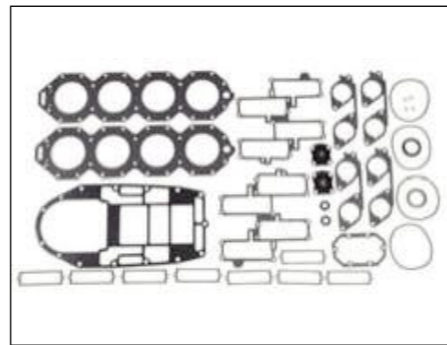

P600245850027
398355



S610245001001
318358



S610245001002
335360

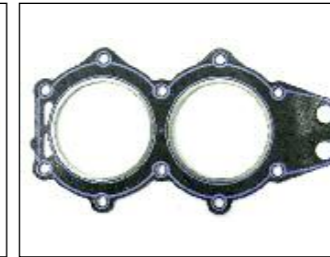

S610245001003
335359



S610245001005
329836



S610245001007
334726

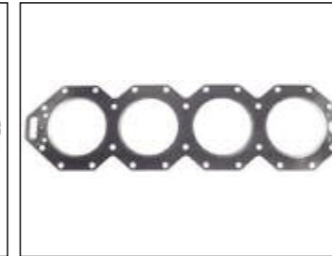

S610245001009
333554



S610245001010
329419



S610245001011
346007



S610245001012
313413



S610245001013
330818



S610245001014
328623

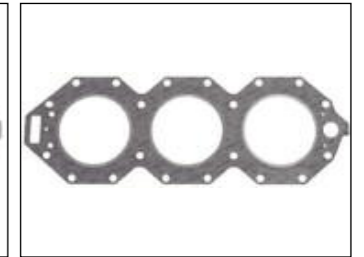

S610245001015
331211



S610245001016
336361



S610245001017
332010



S610245001018
307069



S610245001019
325273



S610245001020
329103



S610245001021
338222

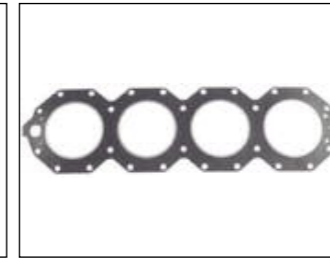

S610245001022
329786



S610245001023
322332

JHONSON EIJNRUDE

JHONSON EIJNRUDE

CUSTOMER SERVICE - SERVIZIO CLIENTI: info@athena-ad.com

CUSTOMER SERVICE - SERVIZIO CLIENTI: info@athena-ad.com



S610334001003
340115

BASE GASKET
GUARNIZIONI BASE CILINDRO

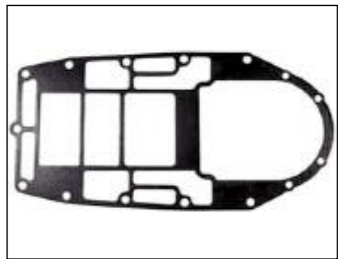

S610245006001
329975

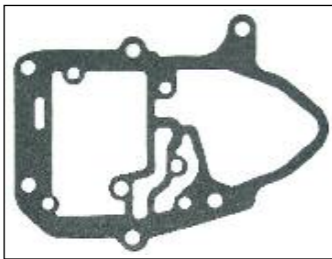

S610245006002
330621



S610245006003
326468

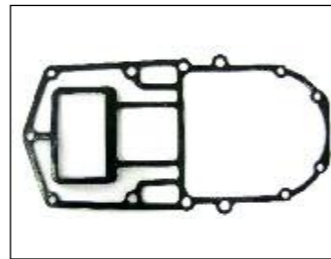

S610245006004
328590



S610245006005
328618



S610245006006
329828

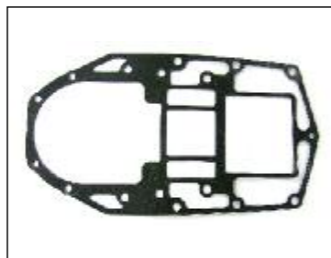

S610245006007
333879

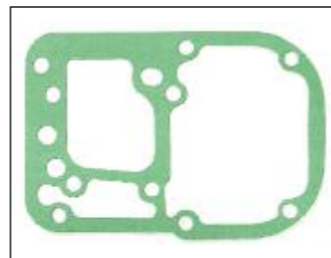

S610245006008
325721



S610245006009
324717

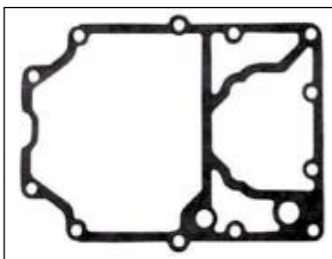

S610245006010
318373



S610245006011
347205

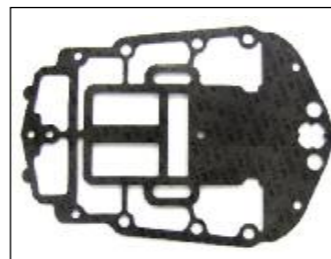

S610245012006
EXHAUST BASE GASKET
N.A.

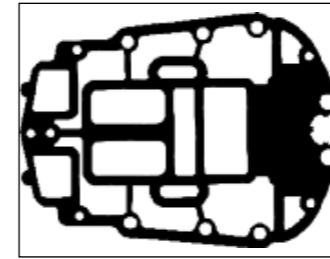

S610245012007
EXHAUST BASE GASKET
339601

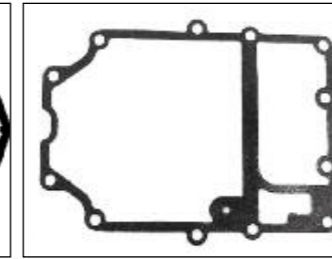

S610245015001
ADAPTER TO HEAD GASKET
321727

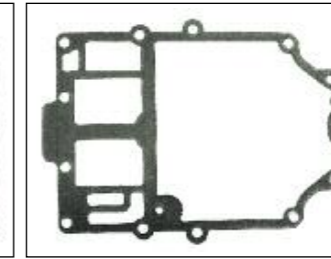

S610245015002
POWERHEAD GASKET
335503

INDIVIDUAL GASKET
GUARNIZIONI SFUSE



S610245010001
LEAF PLATE GASKET
321907

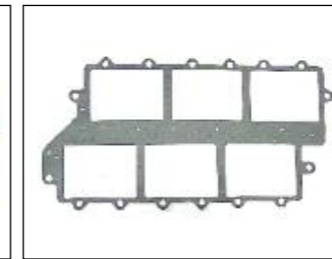

S610245010002
INTAKE MANIFOLD GASKET
319174

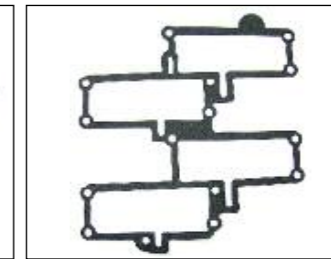

S610245010003
INTAKE GASKET
328622

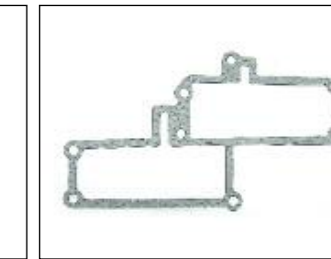

S610245010004
INTAKE GASKET
331532



S610245010005
INTAKE GASKET
335633

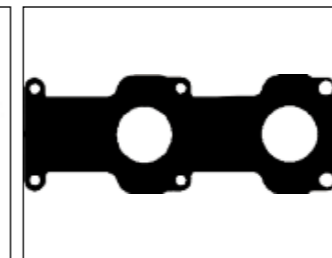

S610245010006
INTAKE GASKET
344526

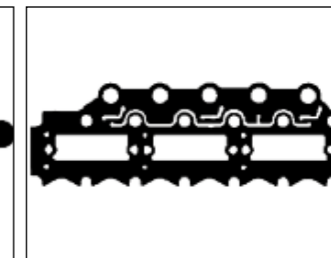

S610245010007 (Viton)
RUBBER GASKET
336227

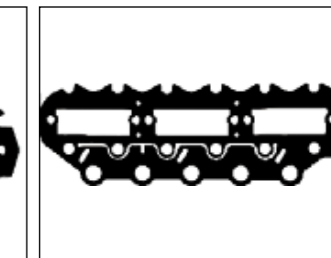

S610245010008 (Viton)
RUBBER GASKET
336226

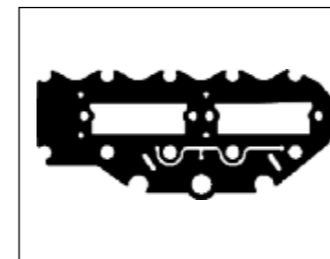

S610245010009 (Viton)
INTAKE MANIFOLD GASKET
336389

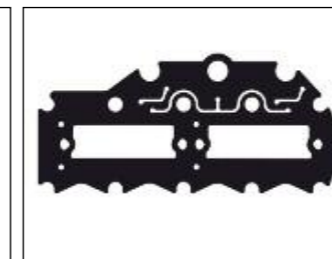

S610245010010 (Viton)
INTAKE MANIFOLD GASKET
336388

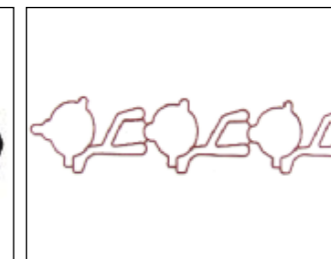

S610245010011
INTAKE MANIFOLD SEAL
335403

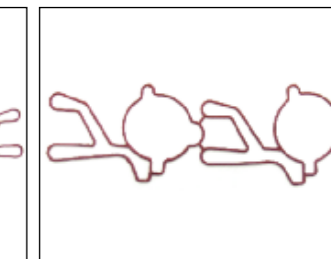

S610245010012
INTAKE MANIFOLD SEAL
335818

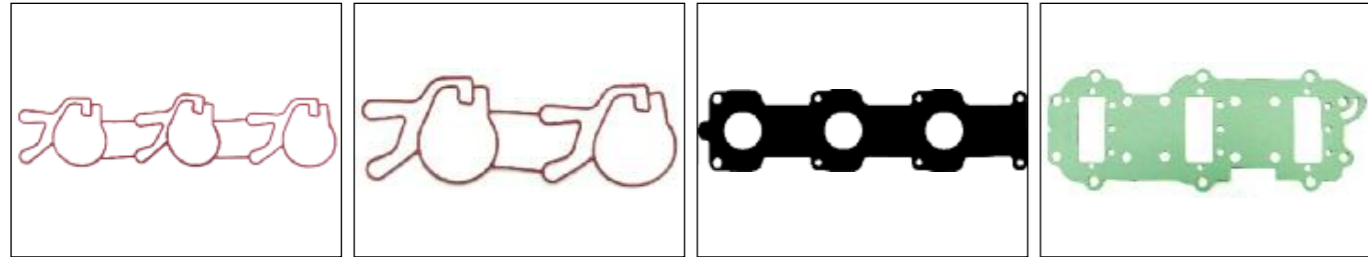

S610245010013 INTAKE MANIFOLD SEAL 335404
S610245010014 INTAKE MANIFOLD SEAL 335819
S610245010015 INTAKE GASKET 344335
S610245010016 INTAKE GASKET 326926

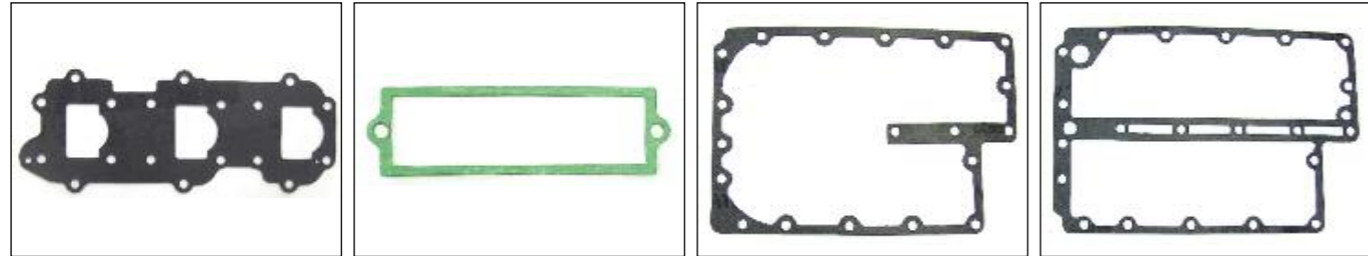

S610245010017 REED GASKET 317305
S610245010018 REED GASKET 332266
S610245012001 EXHAUST PLATE GASKET 317955
S610245012002 EXHAUST COVER GASKET 317914

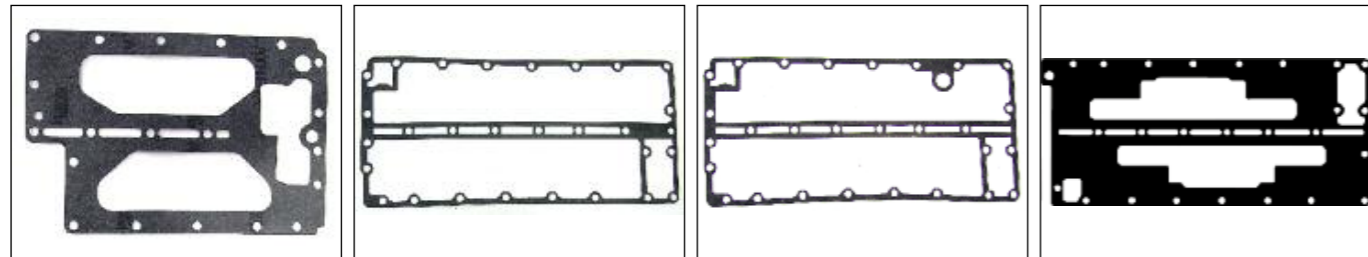

S610245012003 EXHAUST MANIFOLD GASKET 323469
S610245012004 EXHAUST PLATE GASKET 321182
S610245012005 EXHAUST PLATE GASKET 321435
S610245012008 EXHAUST COVER 307133

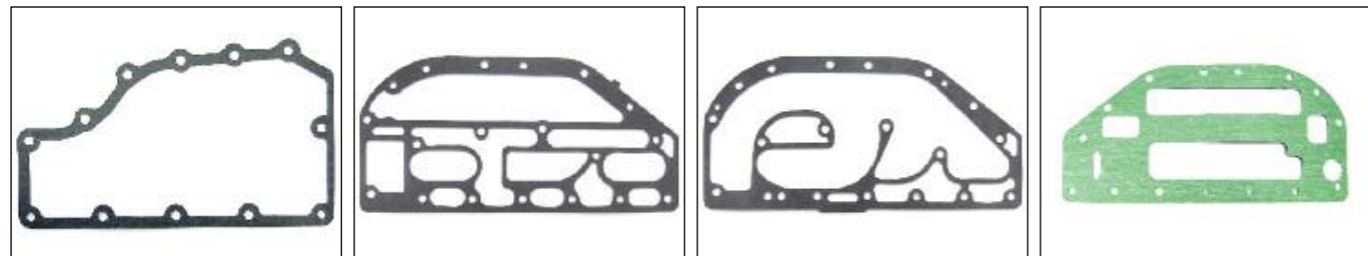

S610245012009 EXHAUST COVER GASKET 325211
S610245012010 INNER EXHAUST GASKET 331917
S610245012011 EXHAUST COVER GASKET 331916
S610245012012 EXHAUST COVER GASKET 329833

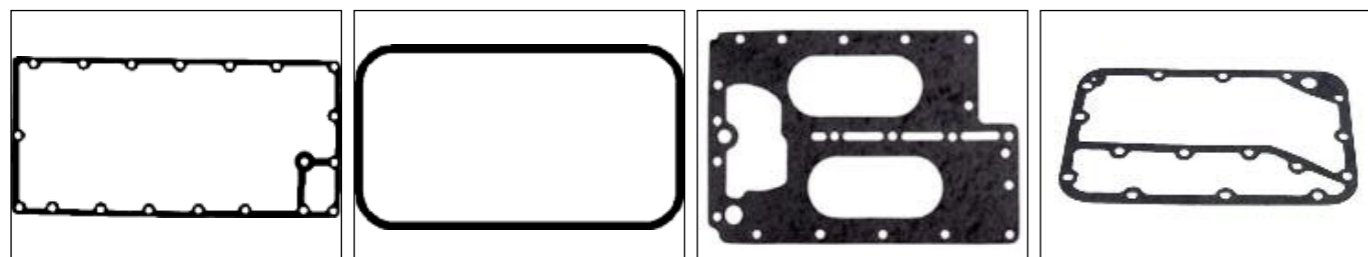

S610245012013 BIG BORE EXHAUST COVER 336430
S610245012014 O-RING RED SILICON 336429
S610245012015 EXHAUST COVER GASKET 318156
S610245012016 EXHAUST COVER GASKET 304762

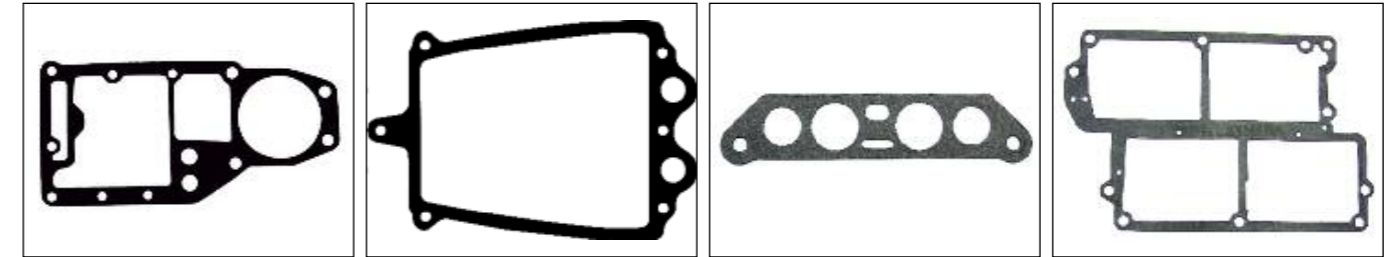

S610245012017 EXHAUST COVER GASKET 319348
S610245015003 ADAPTER TO POWERHEAD 323222
S610245021001 THERMOSTAT GASKET 332369
S610245021002 MANIFOLD CRAKCASE 319174



S610245021003 CYL COVER STARBOARD 318335
S610245021004 AIR SILENCER TO CARBUR. 319771
S610245021005 BY PASS COVER 307133
S610245021006 THERMOSTAT GASKET 321184



S610245021007 CYLINDER COVER GASKET 324323
S610245021008 INNERLEAF PLATE 321479
S610245021009 AIR BOX GASKET 320679
S610245021010 CARB. TO AIR BOX GASKET 321497



S610245021011 CYLINDER COVER 323338
S610245021012 AIR BOX GASKET 331598
S610245021013 CYLINDER COVER GASKET 326264
S610245021014 BY-PASS 319661

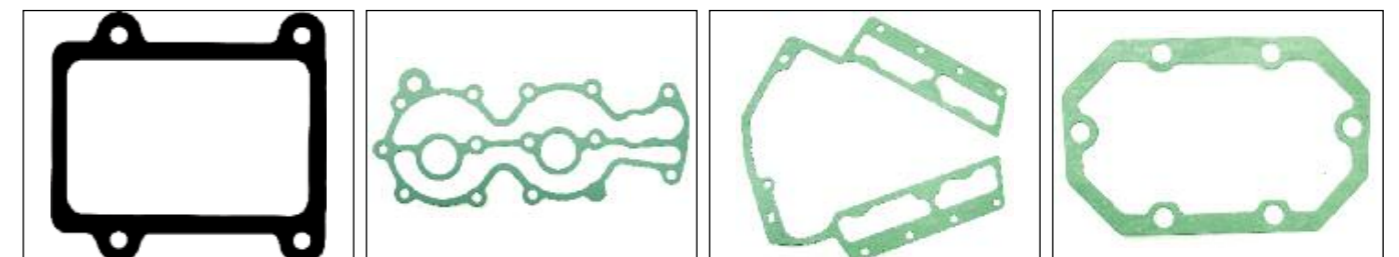

S610245021015 RECTIFIER MOUNT GASKET 342291
S610245021016 HEAD COVER GASKET 315538
S610245021017 AIR BOX GASKET 331101
S610245021018 RECTIFIER MOUN. GASKET 330412

JHONSON EWINRUDE

JHONSON EWINRUDE

CUSTOMER SERVICE - SERVIZIO CLIENTI: info@athena-ad.com

CUSTOMER SERVICE - SERVIZIO CLIENTI: info@athena-ad.com

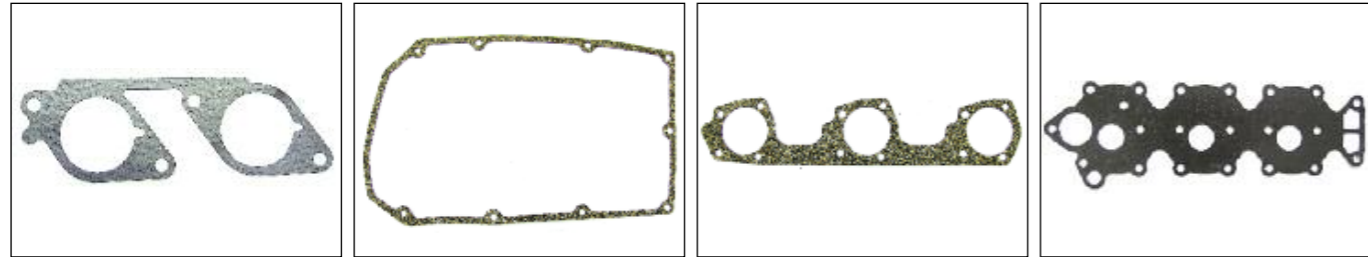

S610245021019 THROTTLE BODY GASKET 332319
S610245021020 AIR BOX GASKET 321794
S610245021021 CARB. TO AIR BOX GASKET 333008
S610245021022 WATER JACKET COVER 318609

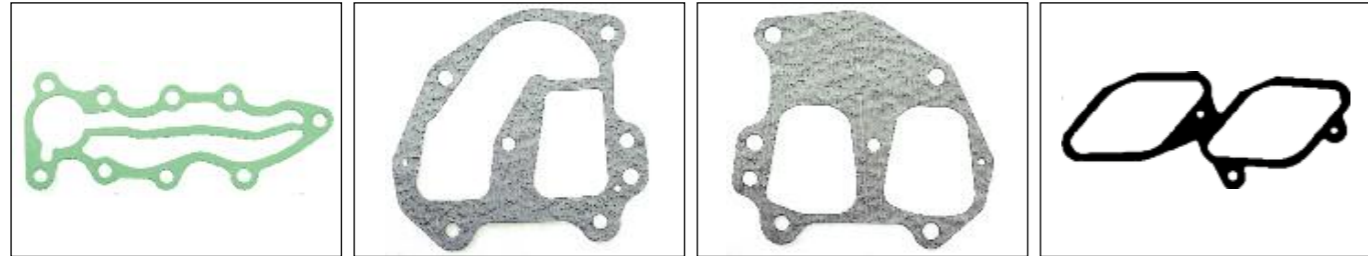

S610245021023 CYLINDER COVER 329920
S610245021024 CYLINDER COVER 325260
S610245021025 CYLINDER COVER 318294
S610245021026 AIR BOX GASKET 328604



S610245021028 AIR BOX GASKET N.A.
S610245021029 POPPET GASKET 337068
S610245021030 PLATE TO CRANKCASE GASKET 311365
S610245021031 MANIFOLD GASKET 311364



S610245021032 BYPASS COVER GASKET 304784
S610245024001 WATER PASSAGE GASKET 317951
S610245024002 WATER JACKET COVER 321028
S610245024003 WATER PASSAGE COVER 322858

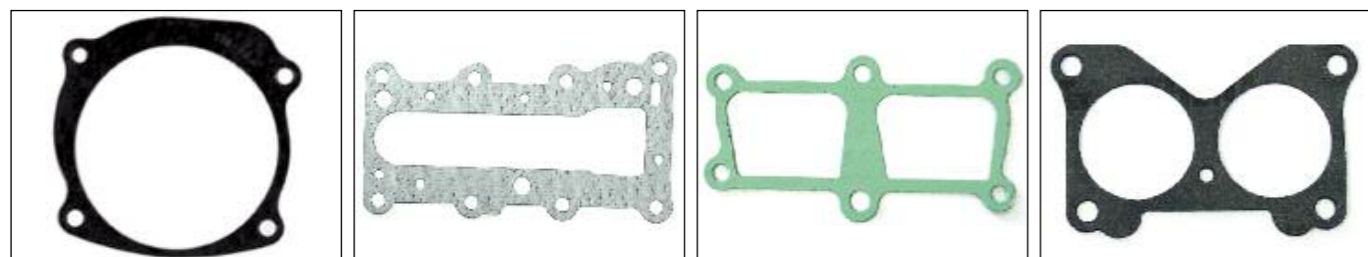

S610245024004 WATER PUMP COVER 338484
S610245047001 GASKET COVER 318925
S610245047002 GASKET COVER 319332
S610245093001 CARBUR. TO MANIFOLD 327707

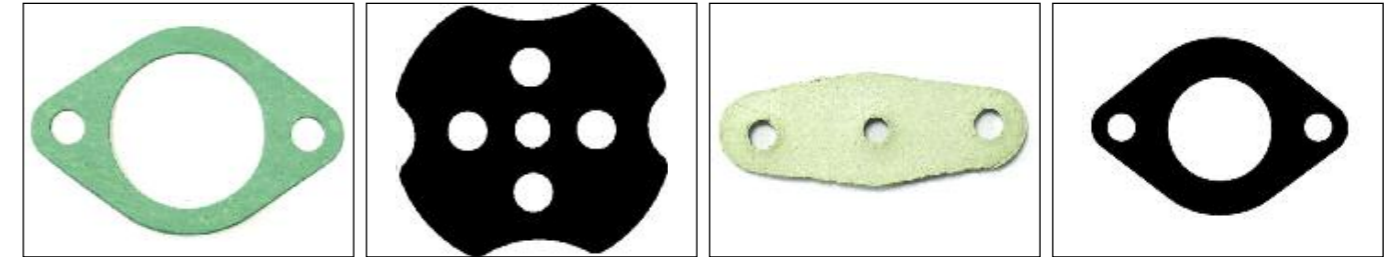

S610245093002 CARBURETOR GASKET 325092
S610245093007 CARBURETOR GASKET 331363
S610245108001 FUEL PUMP GASKET 303615
S610245108002 FLANGE GASKET N.A.

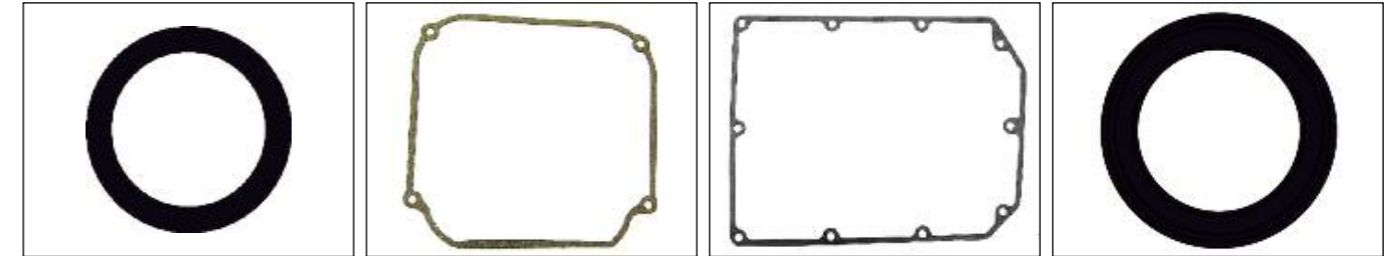

S610245117001 RUBBER CORK WASHER 303355
S610245140001 AIR SILENCER GASKET 321722
S610245140002 AIR SILENCER GASKET 321183
S610245150001 THERMOSTAT GASKET 310058

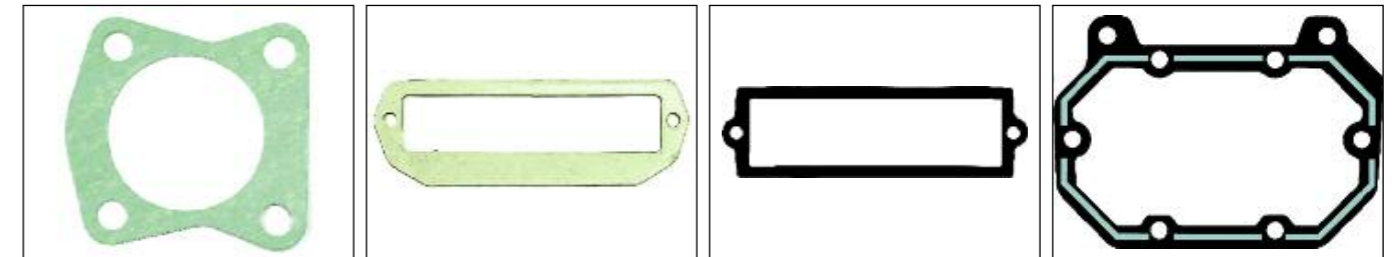

S610245150002 THER. COVER GASKET 329830
S610334010007 REED BOX GASKET 328826
S610334010008 INTAKE GASKET 27-657442
S610334021013 COVER GASKET 344472



S610334021016 OUTER LEAF PLATE 321573
S610334024001 HEAD WATER COVER 327674
S610334047010 THERMO GASKET 332108
S610334047011 CORK THERMO GASKET 313416



S610334108001 GARB GASKET 325092

JHONSON EWINRUDE

JHONSON EWINRUDE

CUSTOMER SERVICE - SERVIZIO CLIENTI: info@athena-ad.com

CUSTOMER SERVICE - SERVIZIO CLIENTI: info@athena-ad.com

APPLICATIONS APPLICAZIONI	YEAR ANNO	SPECIFICATION SPECIFICHE	SERIAL NUMBER NUMERO TELAIO	CYL CIL	GASKET KIT KIT G.NI MOTORE	HEAD GASKET G.NE TESTA CILINDRO	BASE GASKET G.NE BASE CILINDRO	OIL SEAL KIT KIT PARAOLIO	NOTE
200 HP		ProMax	OG857000 & UP	V6 2.5 L	P600334850036	S610334001007	S610334006022	-	NO HEAD GASKET INCLUDED
200 HP		3.0 L DF Optimax	OG3866496-OG589999	V6 3.0 L	P600334850037	M752603400004	S610334006011	-	NO HEAD GASKET INCLUDED - 6 M751802200004 NECESSARY
200 HP		3.0 L DFI Optimax	OG9605-00-OT178499 & UP	V6 3.0 L	P600334850038	S610334001022	S610334012027	-	NO HEAD GASKET INCLUDED
200 HP		3.0 L DFI Optimax	OG590000-OG960499	V6 3.0 L	P600334850039	S610334001023	S610334012027	-	NO HEAD GASKET INCLUDED
210 HP	2001-2003	Sportjet (Carb)		V6 2.5 L	P600334850040	S610334010022	S610334012001	-	
220 HP	1987-1988		B117316 & UP	V6 2.4 L	P600334850041	S610245001004	S610334012001	-	
225 HP	1980-1993	V6 2.4 L	5628028-D280812	V6 2.4 L	P600334850034	S610334001030	S610334006029	-	NO HEAD GASKET INCLUDED
225 HP	1992-UP	XR6	D082000 & UP	V6 2.5 L	P600334999001	S610334001007	S610334012001	-	NO HEAD GASKET INCLUDED 2.5 L MODELS WITH "O-RING" HEAD, ORDER Q.TY 6 PN S610334010022 AND Q.TY 2 PN S610334001017
225 HP		ProMax	OD935638-OT429939	V6 2.5 L	P600334850036	S610334001009	S610334006022	-	NO HEAD GASKET INCLUDED
225 HP		3.0 L EFI	OT409000-UP	V6 3.0 L	P600334850038	S610334001022	S610334012027	-	NO HEAD GASKET INCLUDED
225 HP		3.0 L DFI Optimax	OG960500-OT801000 & UP	V6 3.0 L	P600334850038	S610334001022	S610334012027	-	NO HEAD GASKET INCLUDED
225 HP		3.0 L DFI, DTS	OT599000 & UP	V6 3.0 L	P600334850038	S610334001022	S610334012027	-	NO HEAD GASKET INCLUDED
225 HP		3.0 L DFI Optimax	OG590000-OG960499	V6 3.0 L	P600334850039	S610334001023	S610334012027	-	NO HEAD GASKET INCLUDED
225 HP		3.0 L Carb	OD280813-OG7602999	V6 3.0 L	P600334850006	M751802200004	S610334006011	P600334400006	NO HEAD GASKET INCLUDED - 6 M751802200004 NECESSARY
225 HP		3.0 L Carb	OG245605-OT408999	V6 3.0 L	P600334850006	M751802200004	S610334006011	P600334400006	NO HEAD GASKET INCLUDED - 6 M751802200004 NECESSARY
225 HP		3.0 L EFI	OG76300-OT408999	V6 3.0 L	P600334850006	M751802200004	S610334006011	P600334400006	NO HEAD GASKET INCLUDED - 6 M751802200004 NECESSARY
225 HP		3.0 L EFI	OG129222-OT408999	V6 3.0 L	P600334850006	M751802200004	S610334006011	P600334400006	NO HEAD GASKET INCLUDED - 6 M751802200004 NECESSARY
225 HP		4-Stroke EFI	OT653945 & UP	V6	P600334850042	S610334001018 S610334001019	S610334006025	-	
240 HP	2001-2003	Sport Jet EFI		V6	P600334850045	S610334010022	S610334006022	-	
250 HP		3.0 L EFI Optimax	OT409000-OT800999 & UP	V6 3.0 L	P600334850038	S610334001022	S610334012027	-	NO HEAD GASKET INCLUDED-
250 HP		3.0 L EFI	OG129222-OT408999	V6 3.0 L	P600334850006	M751802200004	S610334006011	P600334400006	NO HEAD GASKET INCLUDED
250 HP		XB 3.0 L	OG980600-OT800999	V6 3.0 L	P600334850006	M751802200004	S610334006011	P600334400006	NO HEAD GASKET INCLUDED - 6 M751802200004 NECESSARY
250 HP		XS 3.0 L DFI	OT651945-OT818042	V6 3.0 L	P600334850043	M751802200004	S610334006010	-	
250 HP		Sportjet DFI 3.0 L		V6	P600334850046	M751802200004	S610334012027	-	
260 HP		EFI Hi-Perf Offshore	OG367000-OG85699 & UP	V6 2.5 L	P600334850044	M751802200004	S610334006022	-	NO HEAD GASKET INCLUDED
280 HP		EFI Hi-Perf Offshore	OG367000-OG85699 & UP	V6 2.5 L	P600334850044	M751802200004	S610334006022	-	NO HEAD GASKET INCLUDED
300 HP		300 X 3.0 L EFI, ProMax	OT235084-OT429940 & UP	V6 3.0 L	P600334850038	S610334001022	S610334012027	-	NO HEAD GASKET INCLUDED
300 HP		3.0 EFI, ProMax, Super Mag	OG610221-OT105297	V6 3.0 L	P600334850006	M751802200004	S610334006011	P600334400006	NO HEAD GASKET INCLUDED - 6 M751802200004 NECESSARY
2.5 L		DFI	OG960500-OT178499	V6 2.5 L	P600334850030	S610334010022	S610334006010	-	NO HEAD GASKET INCLUDED



P600334999001
27-815791A92

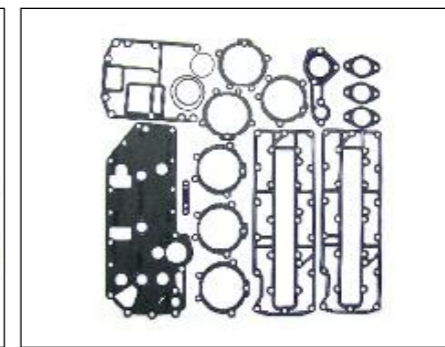

P600334850004
27-43004A99

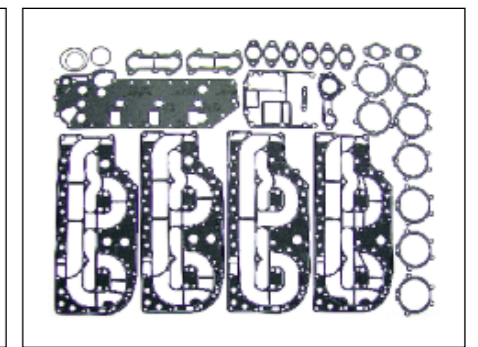

P600334850005
27-13461A99



P600334850006
27-814195A93

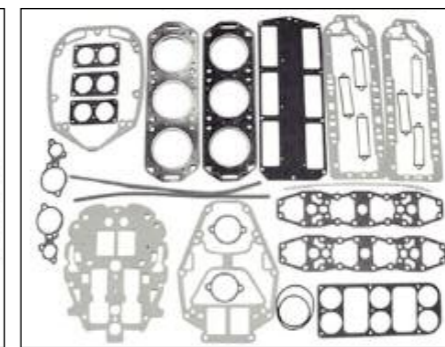

P600334850007
27-90484A88

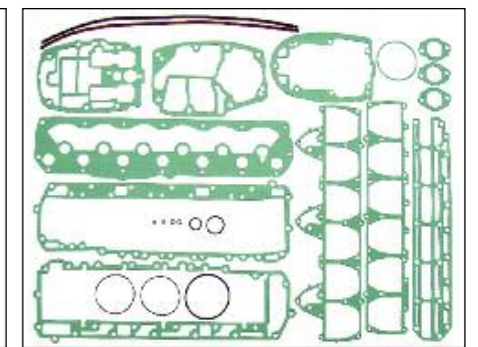

P600334850008
27-85653A87

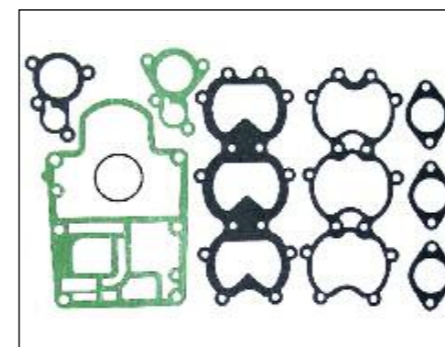

P600334850009
27-812867A91

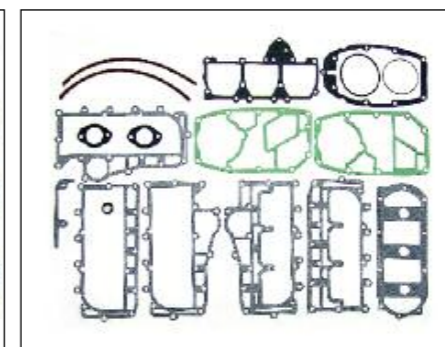

P600334850010
27-69524A75

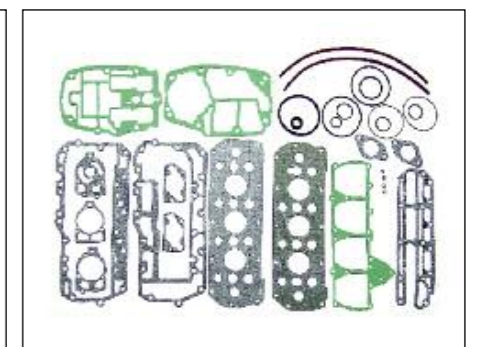

P600334850011
27-73645A87

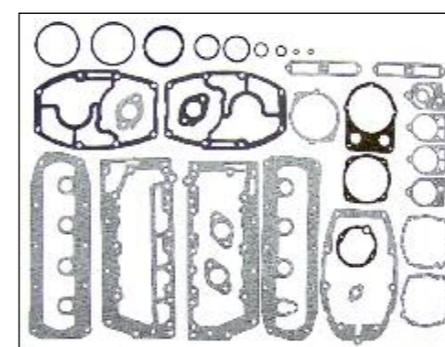

P600334850012
27-72486A32

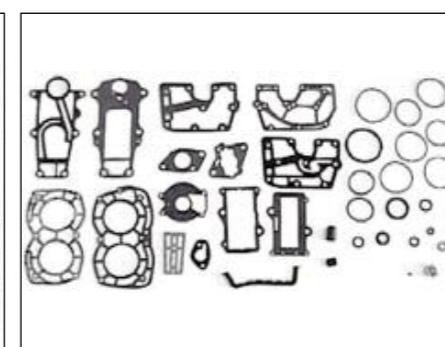

P600334850014
27-41499A88

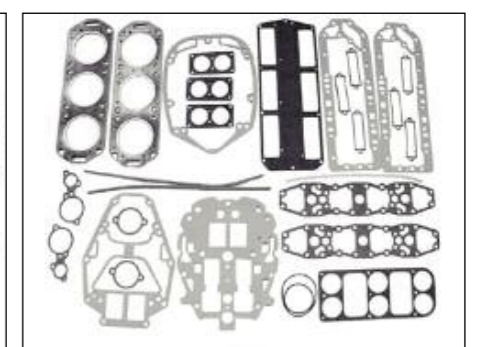

P600334850015
27-11338A88

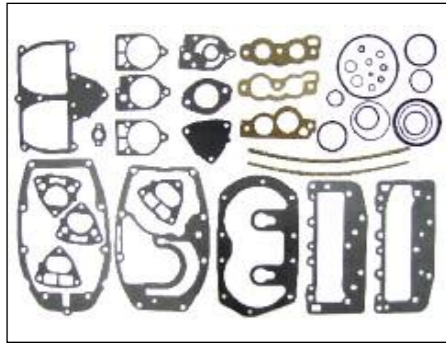

P600334850016
27-78028A78

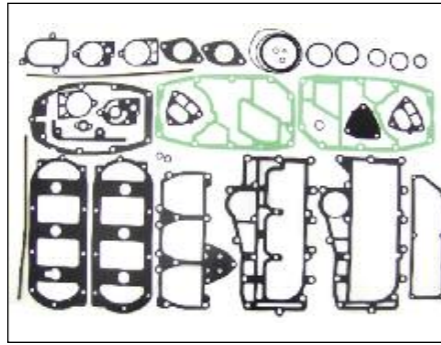

P600334850017
27-88449A32

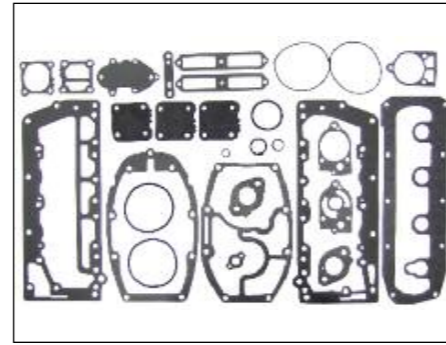

P600334850018
27-85491A90

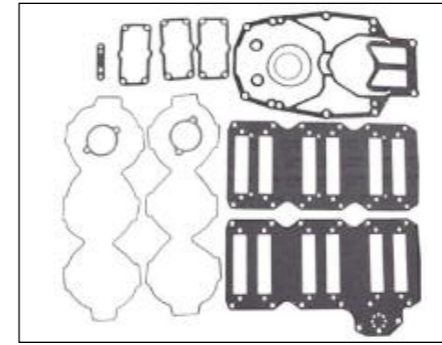

P600334850037
27-814195A97

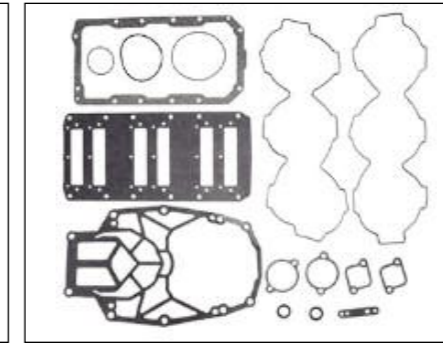

P600334850038
27-832934A00

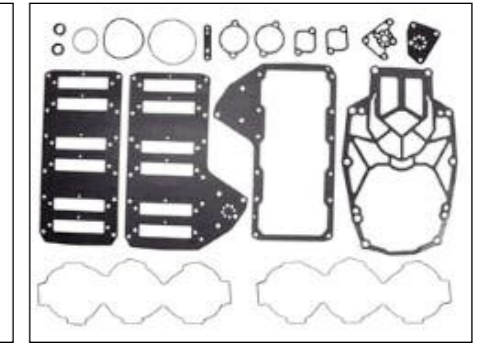

P600334850039
27-832934A00

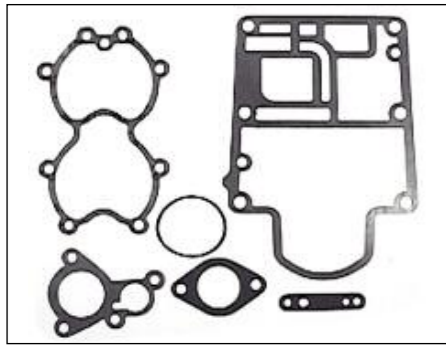

P600334850028
27-822420A94

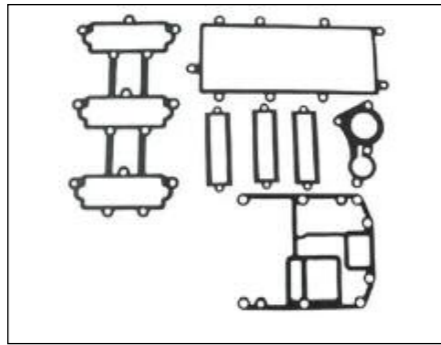

P600334850029
27-879855A04

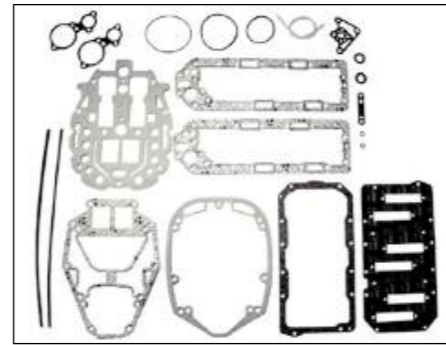

P600334850030
27-81475A00

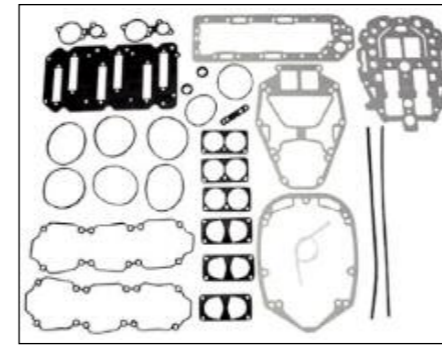

P600334850040
27-804985A1

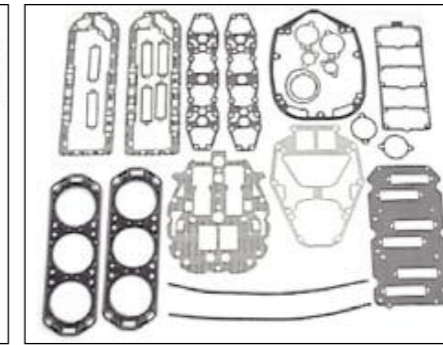

P600334850041
27-14697A87

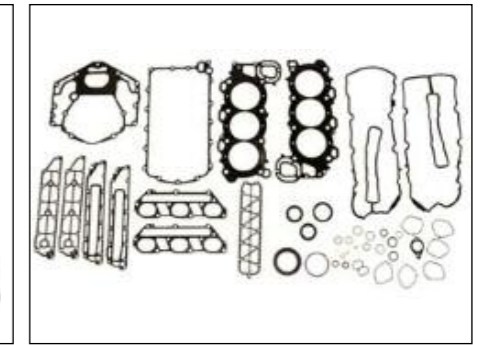

P600334850042
27-887810A04

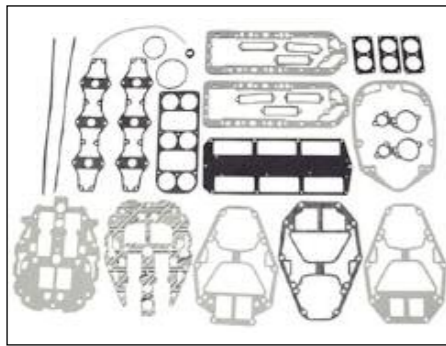

P600334850031
27-79583A9

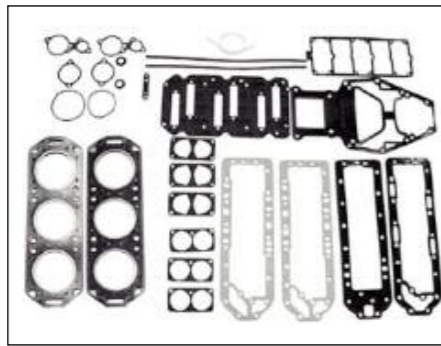

P600334850032
27-850396A1

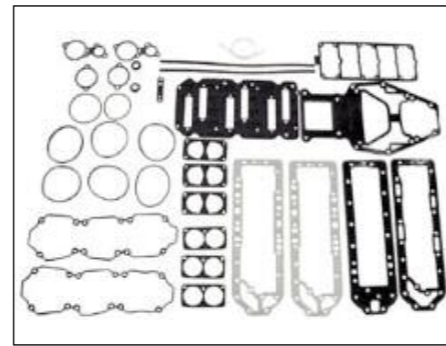

P600334850033
27-804852A1

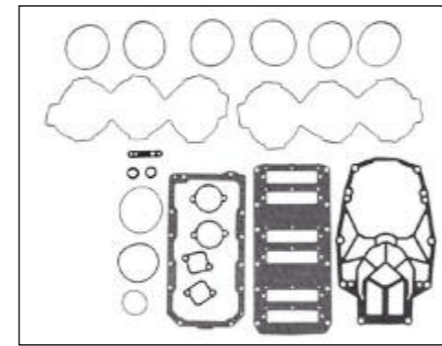

P600334850043
27-841220A03

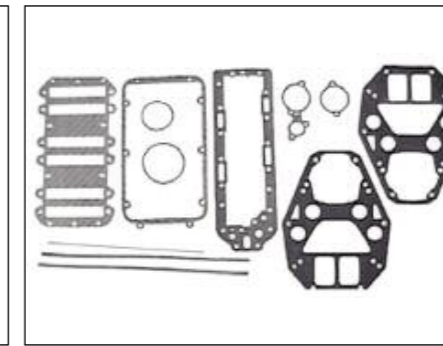

P600334850044
27-814658A98

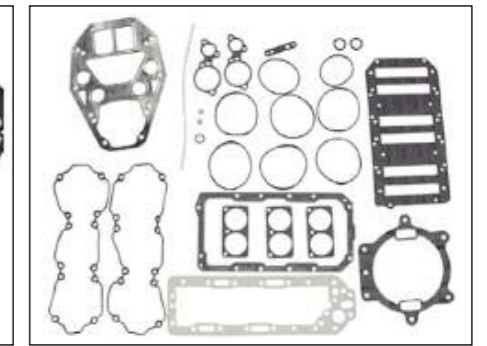

P600334850045
27-885214A1

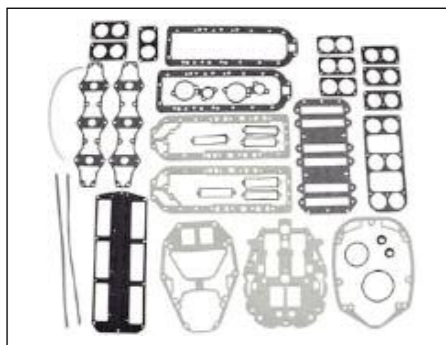

P600334850034
27-89221A80



P600334850035
27-883298A1

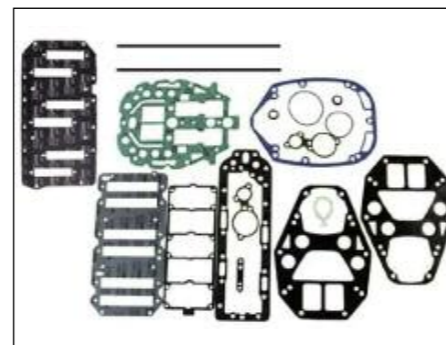

P600334850036
N.A.

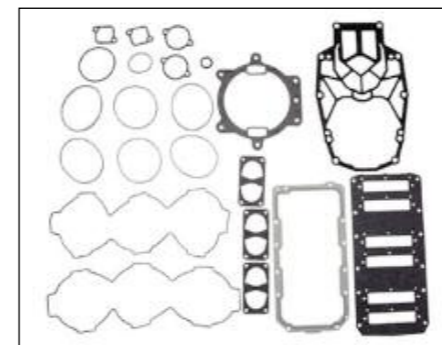

P600334850046
27-889439A01

MERCURY

MERCURY

CUSTOMER SERVICE - SERVIZIO CLIENTI: info@athena-ad.com

CUSTOMER SERVICE - SERVIZIO CLIENTI: info@athena-ad.com

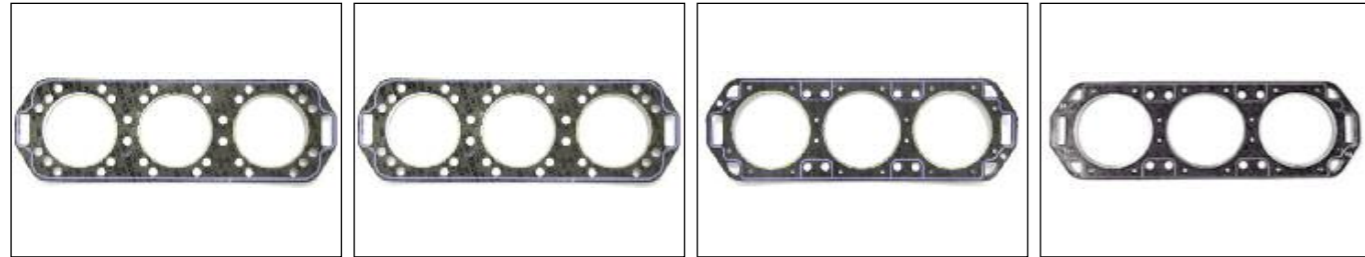

S610334001005 27-96542-1
S610334001006 27-795831
S610334001007 27-82244-1
S610334001009 27-814658-1

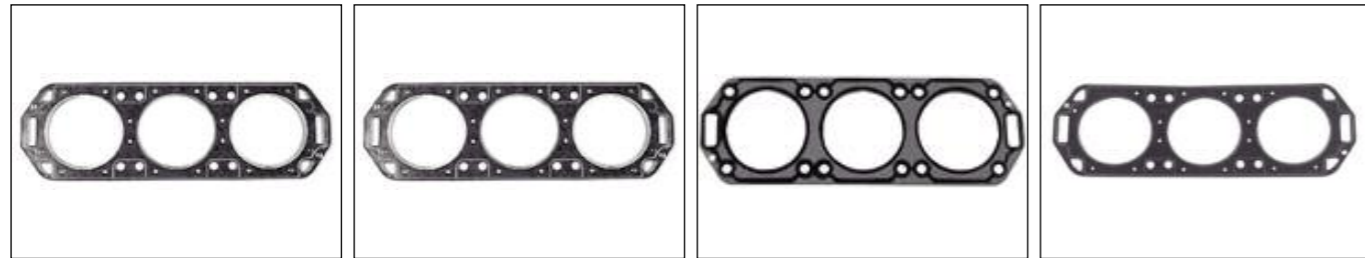

S610334001010 27-814658-75
S610334001011 27-18785-1
S610334001012 27-852520-3
S610334001015 27-18786-1

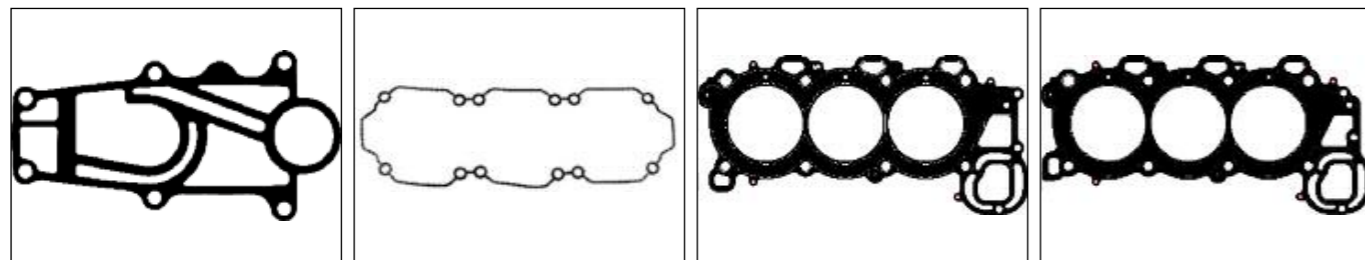

S610334001016 27-41670-3
S610334001017 858452-1
S610334001018 27-887848-1
S610334001019 27-887848

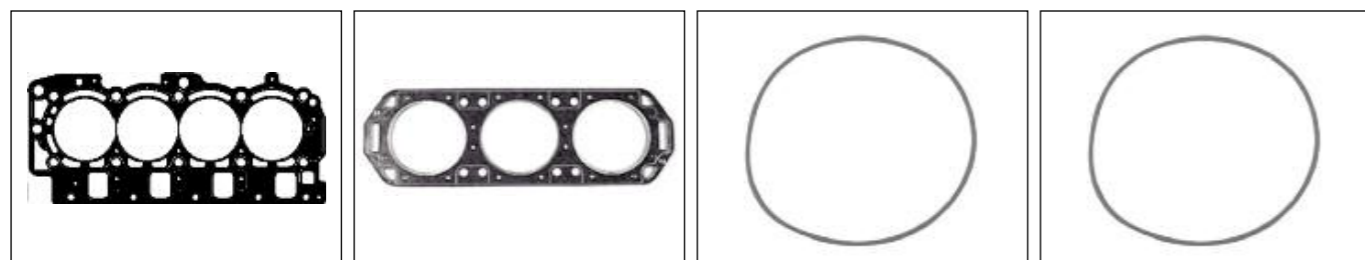

S610334001020 27-858081
S610334001021 27-41245-1
S610334001022 25-818573
S610334001023 25-884391



S610245001004 27-41246-1

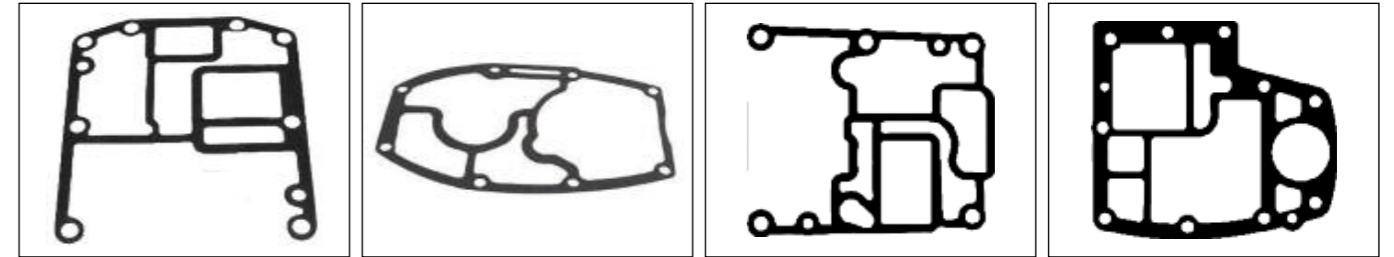

S610334006002 27-43007-1
S610334006003 27-79650-1
S610334006004 27-826738
S610334006005 27-82687-1

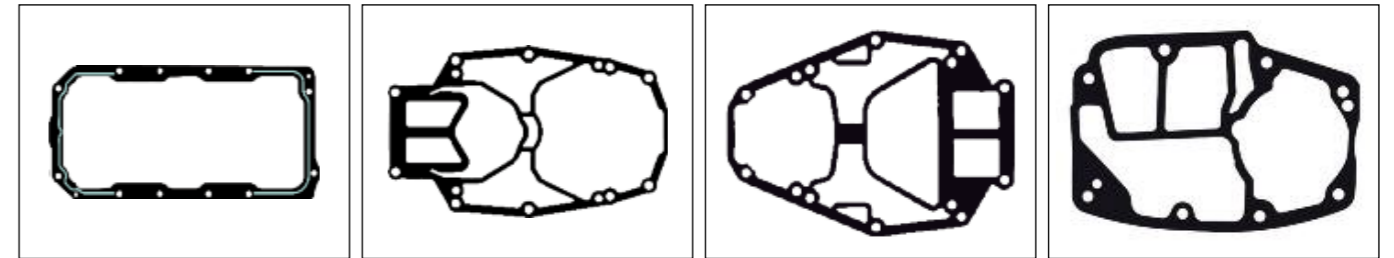

S610334006010 27-856542-1
S610334006011 27-813932-2
S610334006012 27-99176-1
S610334006013 27-69238-1

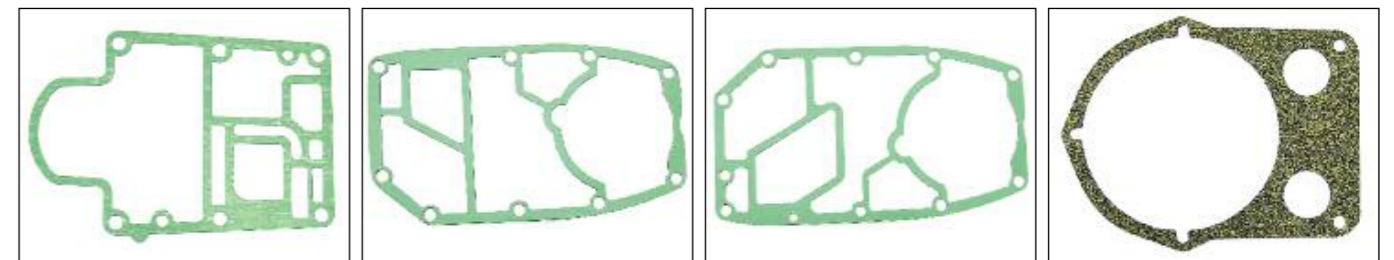

S610334006015 27-828553
S610334006016 27-60317
S610334006017 27-88451-1
S610334006020 N.A.

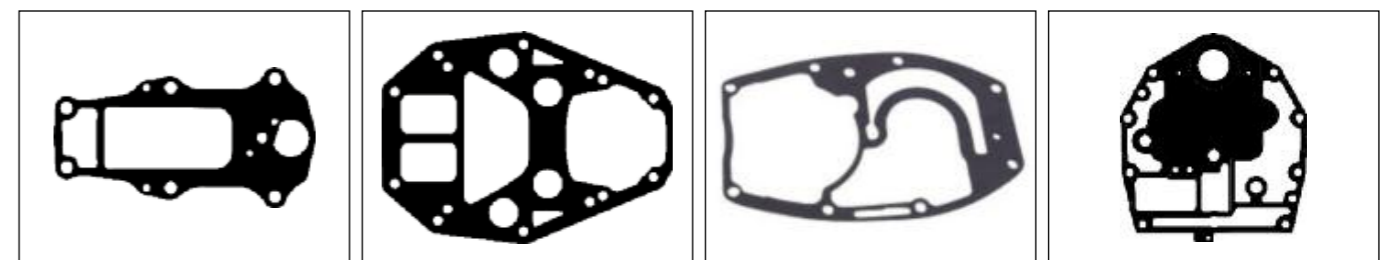

S610334006021 27-43337-4
S610334006022 27-82314-2
S610334006023 27-62680-1
S610334006024 27-892319001

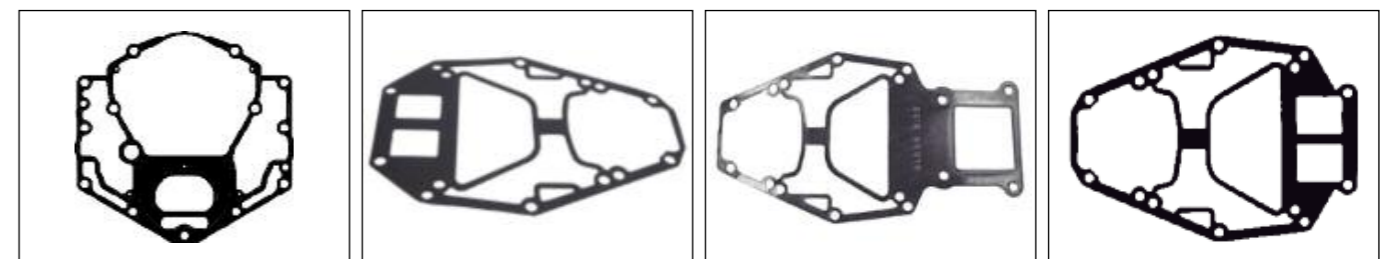

S610334006025 27-887810011
S610334006028 27-78069
S610334006029 27-830242
S610334012001 27-99176-1

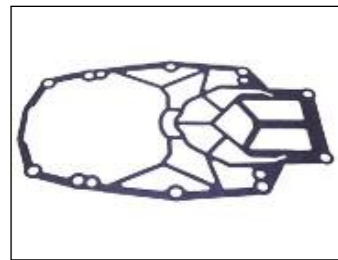

S6103340120017
27-832933-5

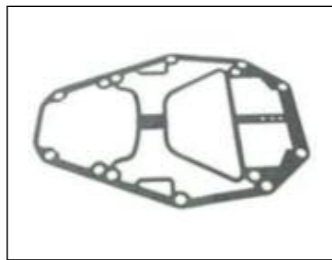

S610334012026
27-75909

INDIVIDUAL GASKET
GUARNIZIONI SFUSE

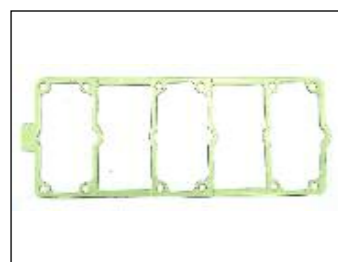

S610334010001
INTAKE GASKET
27-16737-1

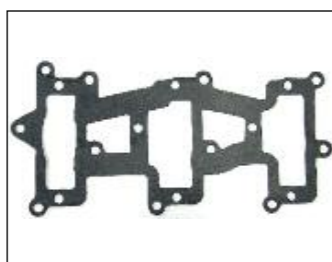

S610334010002
INTAKE GASKET
27-f851591



S610334010003
INTAKE GASKET
27-F406406

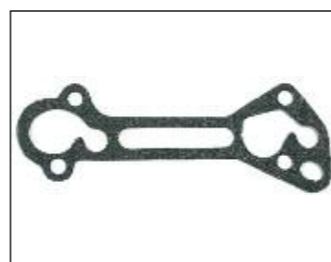

S610334010004
INTAKE GASKET
27-F847483



S610334010005
INTAKE GASKET
27-F844725

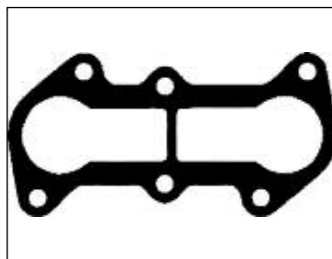

S610334010006
INTAKE GASKET
27-134612

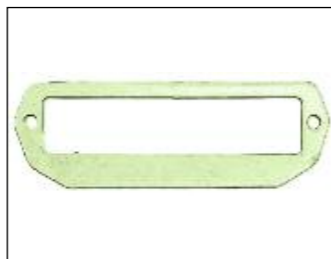

S610334010007
INTAKE GASKET
328826

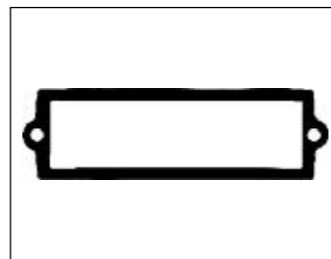

S610334010008
INTAKE GASKET
332266

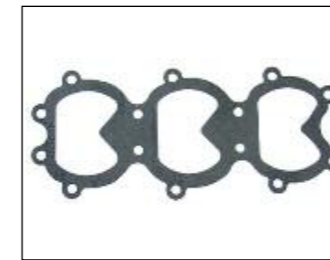

S610334010009
INTAKE GASKET
27-812868

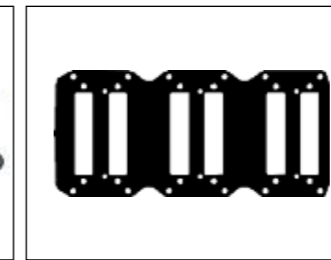

S610334010011
INTAKE GASKET
27-814895-1

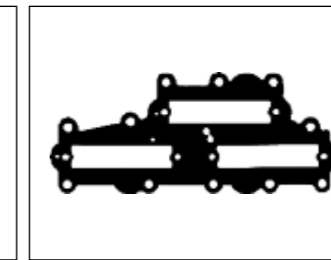

S610334010012
CARBURETOR GASKET
27-819113

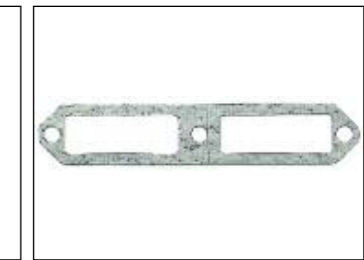

S610334010013
INTAKE VALVE GASKET
27-27936-1

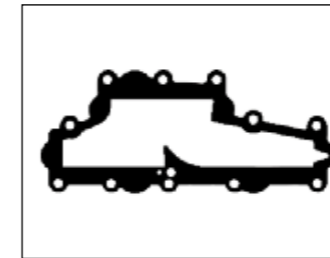

S610334010014
INTAKE COVER
27-8191141



S610334010015
INTAKE VALVE GASKET
N.A.



S610334010016
CYLINDER INTAKE
N.A.

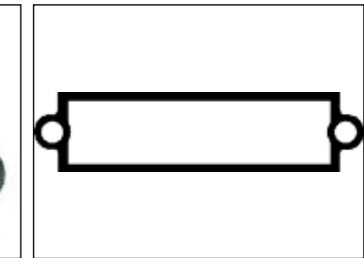

S610334010017
REED GASKET
27-657442

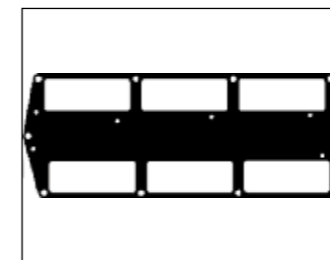

S610334010018
REED GASKET
27-93536

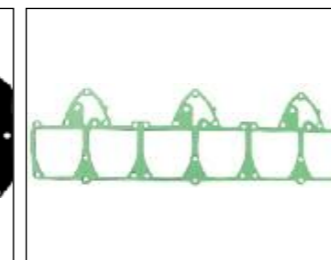

S610334010019
INTAKE COVER
27-64941

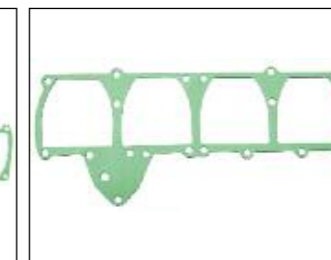

S610334010020
INTAKE GASKET
27-73645

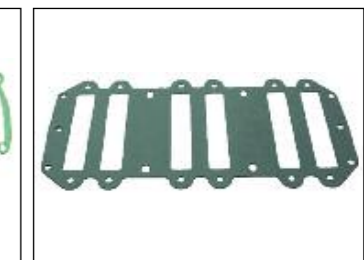

S610334010021
INTAKE GASKET
27-12775-4



S610334010023
COVER GASKET
27-55279-1



S610334010024
INTAKE GASKET
27-880122

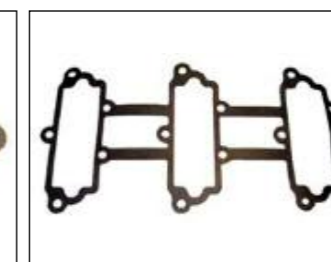

S610334010025
INTAKE GASKET
27-879840

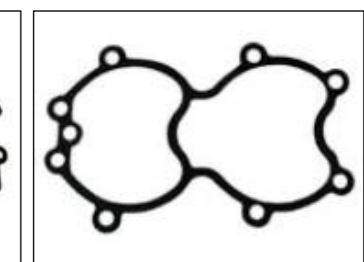

S610334010026
INTAKE GASKET
27-821370

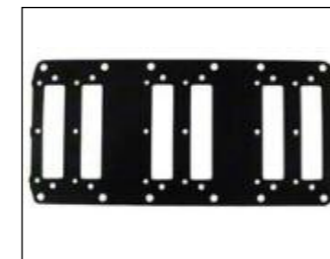

S610334010027
INTAKE GASKET
27-804680

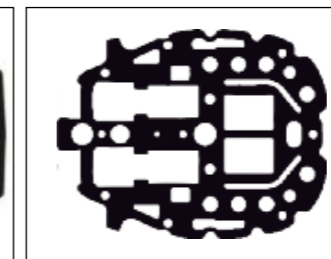

S610334012002
DRIVE SHAFT HOUS.
27-18307-1

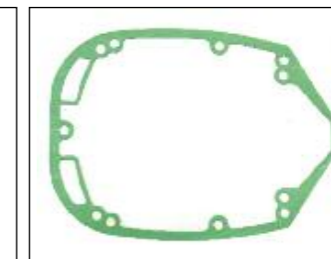

S610334012003
DRIVE HOUSING GASKET
27-99173-2

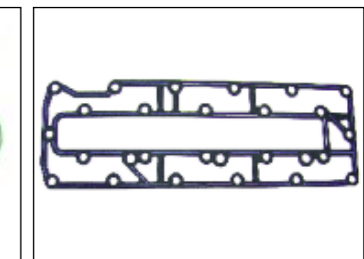

S610334012004
EXHAUST GASKET
27-43004-7

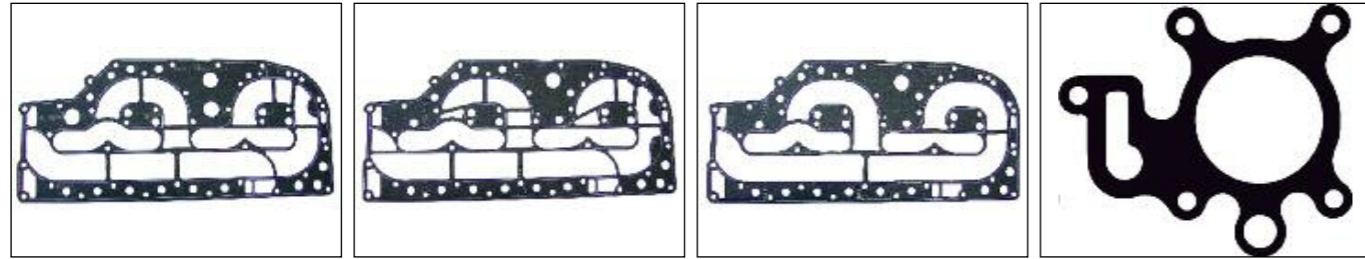

S610334012005
EXHAUST GASKET
N.A.

S610334012006
EXHAUST GASKET
27-812775

S610334012007
EXHAUSTPLATE L4
27-812775-1

S610334012008
EXHAUST GASKET
323459

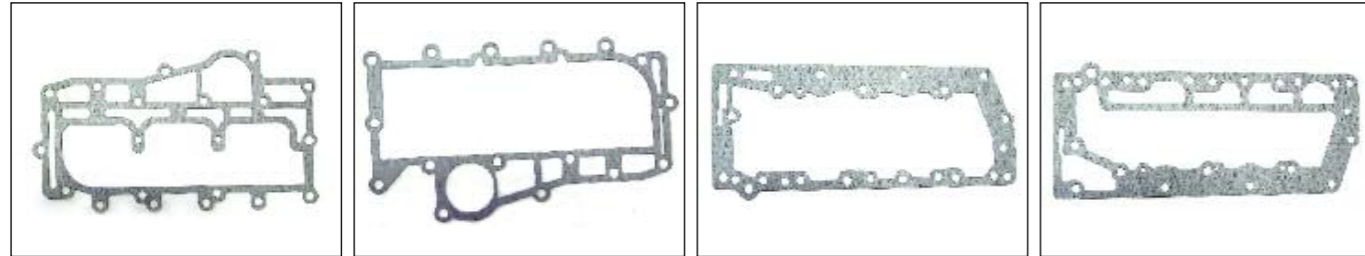

S610334012010
EXHAUST PLATE GASKET
27-69525-2

S610334012011
EXHAUST GASKET
27-69524-2

S610334012012
EXHAUST GASKET
27-85491-3

S610334012013
EXHAUST GASKET
27-85492-2

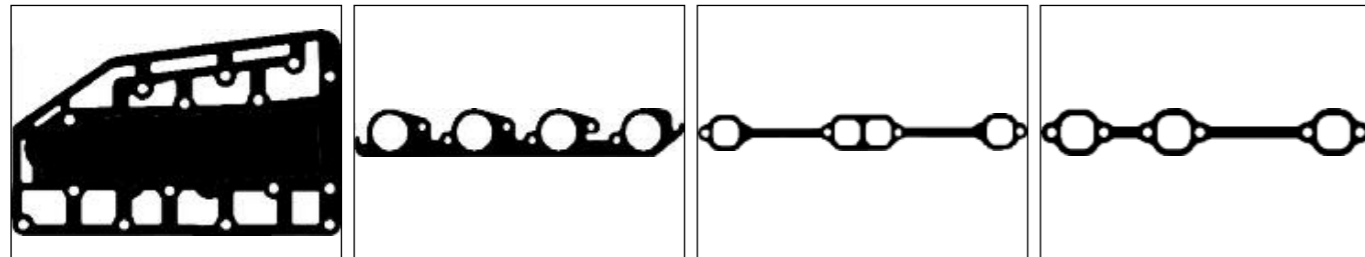

S610334012014
COVER GASKET
N.A.

S610334012015
COVER GASKET
N.A.

S610334012016
EXHAUST GASKET
27-33395

S610334012017
EXHAUST GASKET
27-99757

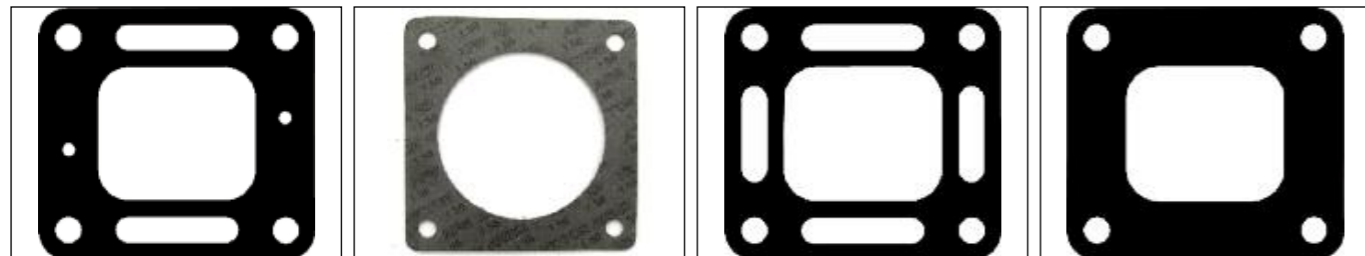

S610334012018
EXHAUST GASKET
27-41813

S610334012019
EXHAUST GASKET
N.A.

S610334012020
EXHAUST GASKET
27-87105-1

S610334012021
EXHAUST GASKET
N.A.

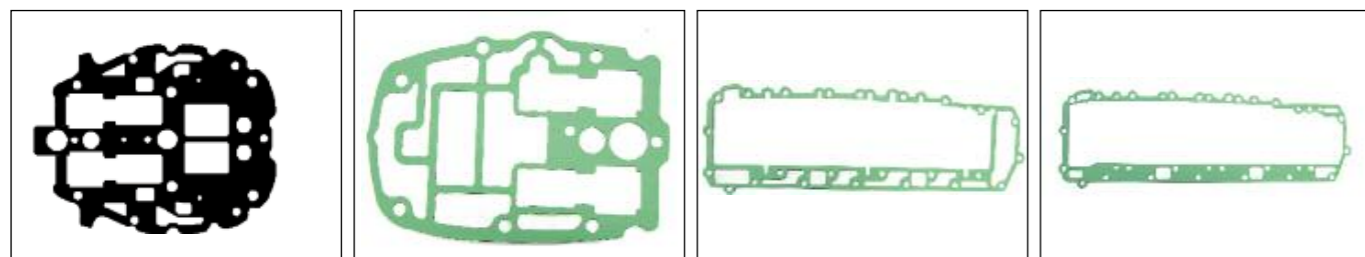

S610334012022
EXHAUST PLATE GASKET
27-999177

S610334012023
EXHAUST GASKET
N.A.

S610334012024
EXHAUST COVER GASKET
27-854972

S610334012025
EXHAUST COVER GASKET
27-854922

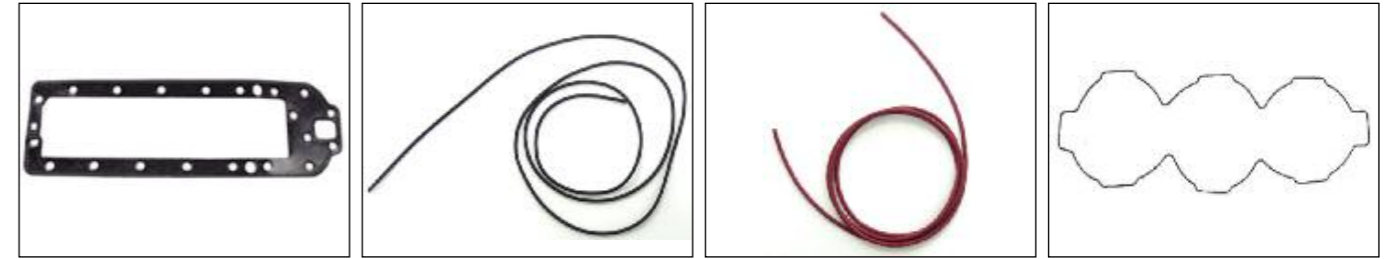

S610334012030
EXHAUST GASKET
27-855874

S610334015001
SILICON GASKET
N.A.

S610334015002
SILICON GASKET
N.A.

S610334015006
SILICON GASKET
29-818574

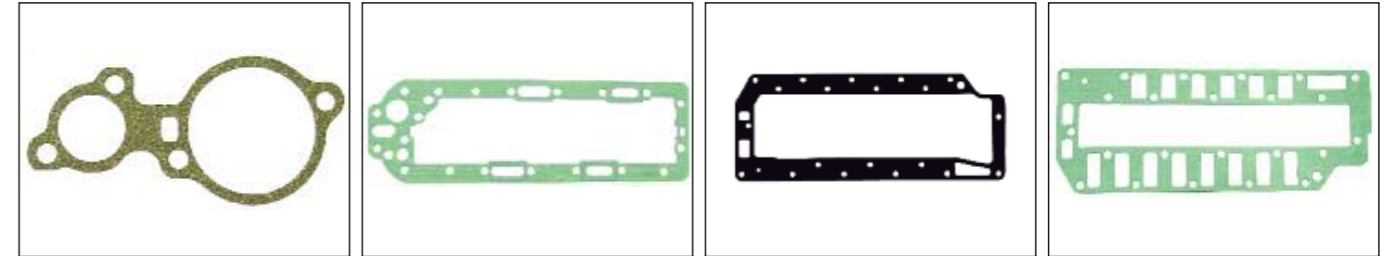

S610334021001
RELIEF VALVE GASKET
27-78690

S610334021002
DIVIDER PLATE GASKET
27-190503

S610334021003
COVER GASKET
27-F851541

S610334021004
COVER GASKET
27-8190231

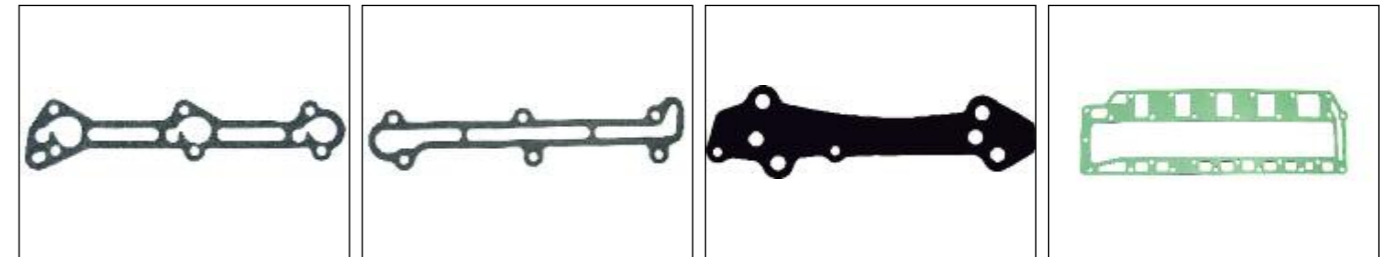

S610334021005
COVER GASKET
27-F857482

S610334021006
COVER GASKET
27-F854722

S610334021007
COVER GASKET
27-F686472

S610334021008
EXHAUST GASKET
27-8190242

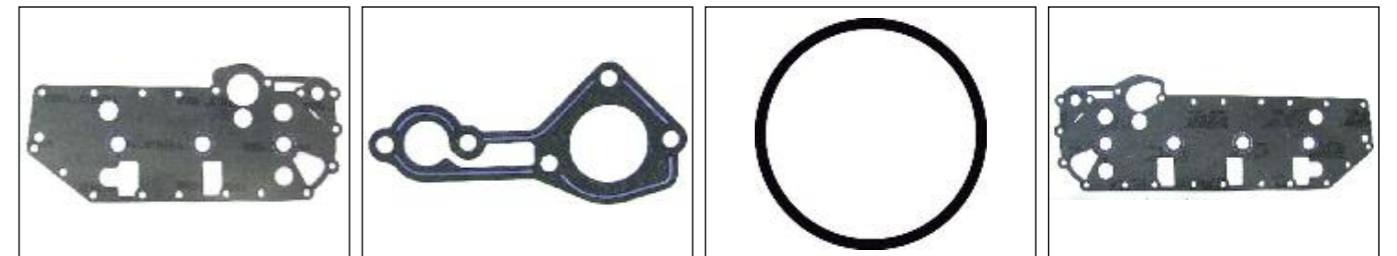

S610334021009
WATER COVER GASKET
27-43005-7

S610334021010
THERMO GASKET
27-43006-2

S610334021011
RUBBER GASKET 54x59x2,5
N.A.

S610334021012
WATER PUMP GASKET
27-44328-4

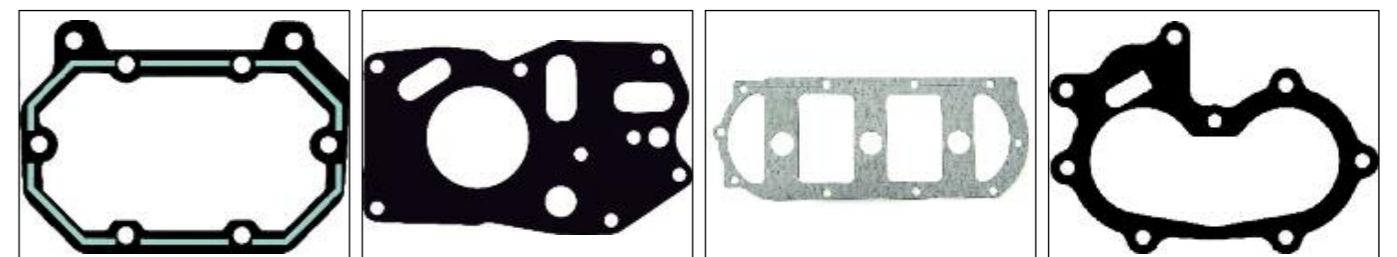









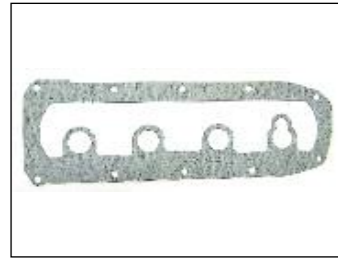
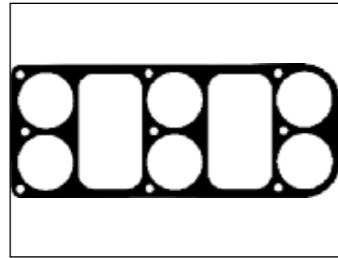
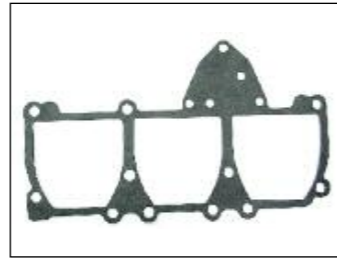
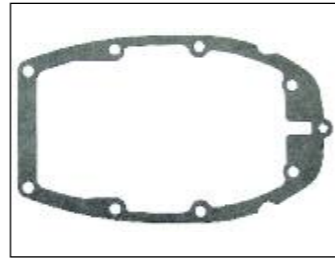
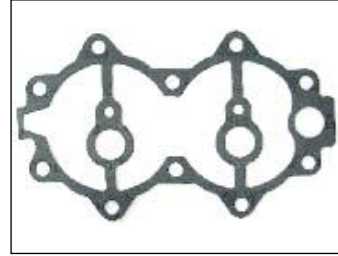

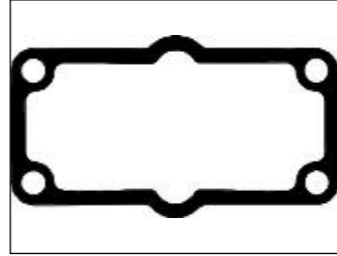

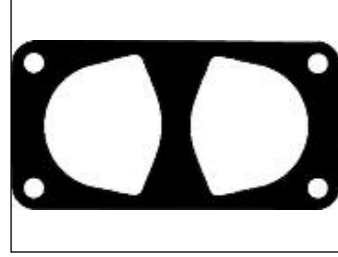
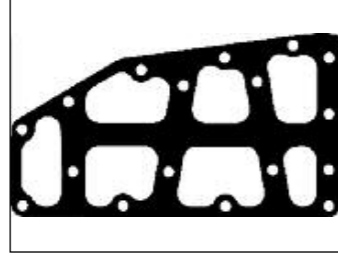
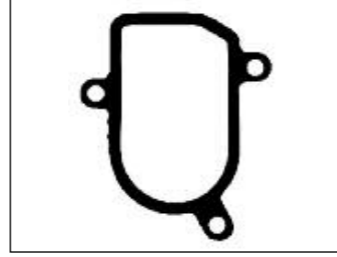
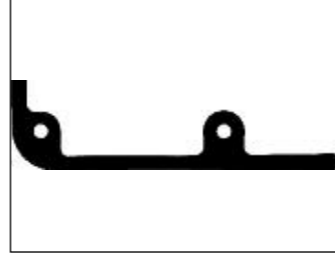





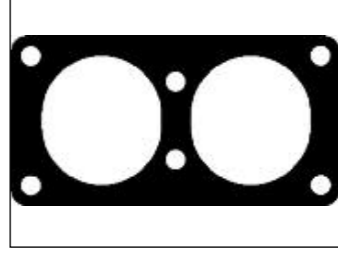
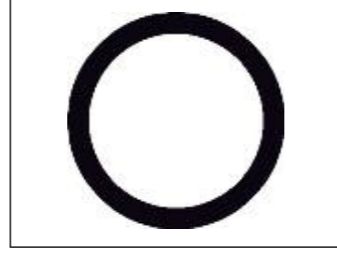
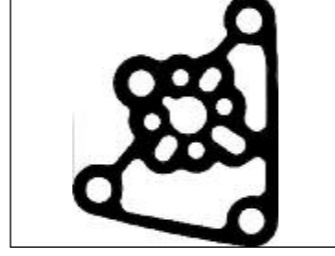

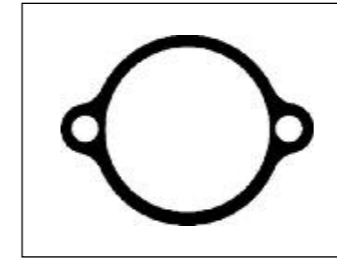
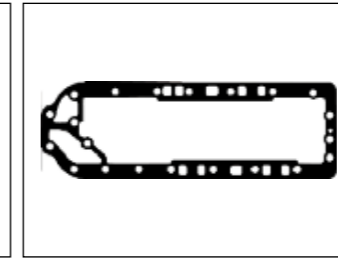
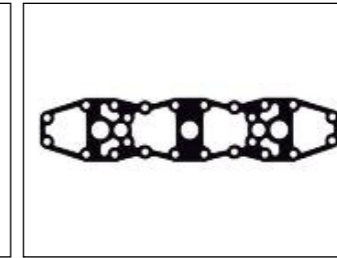

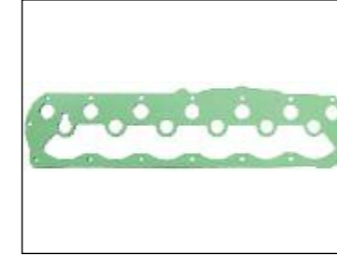
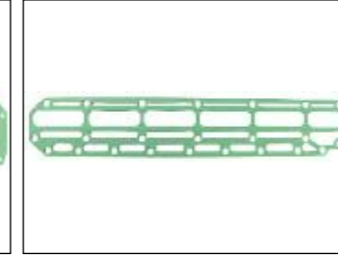
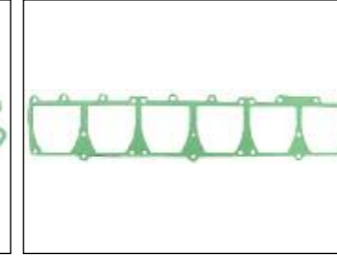
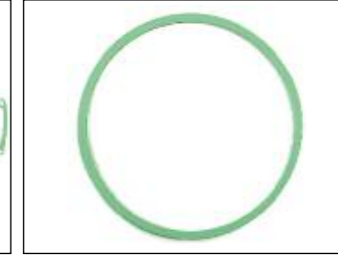

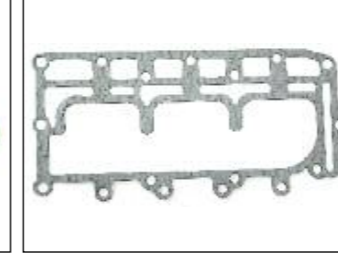
S610334021013
COVER GASKET
344472

S610334021014
COVER GASKET
N.A.

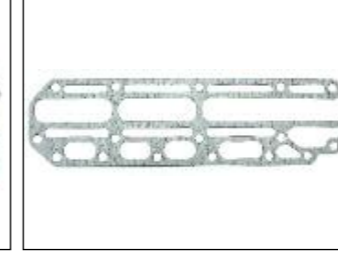
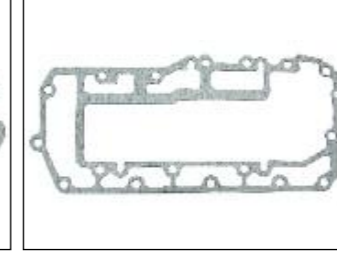
S610334021015
COVER GASKET
27-43779-2

S610334021016
INTAKE VALVE GASKET
326260

			
S610334021017 COVER GASKET 27-43777-2	S610334021018 AIR BOX CARBURETOR 27-672741	S610334021019 INTAKE COVER GASKET 27-73645	S610334021020 COVER GASKET 27-38501-1
			
S610334021021 COVER GASKET N.A.	S610334021022 COVER GASKET 27-85487	S610334021023 EFI GASKET 27-825815	S610334021024 THERMO GASKET 27-812861-1
			
S610334021025 CARB. MOUNT GASKET 27-828292	S610334021026 FLANGE GASKET N.A.	S610334021027 MOTOR COVER GASKET N.A.	S610334021028 COVER GASKET 27-70335-1
			
S610334021029 THERMOSTAT GASKET 27-F93472-1	S610334021030 CYLINDER DRAIN COVER N.A.	S610334021031 CARBURETOR GASKET N.A.	S610334021032 CYLINDER COVER 27-F93472-1
			
S610334021033 CARBURETOR GASKET 27-F97067	S610334021034 CARBURETOR GASKET 27-90430	S610334021035 COVER GASKET N.A.	S610334021036 COVER GASKET 27-856452-1

			
S610334021038 POPPET VALVE GASKET 27-88907	S610334021039 DIVIDER PLATE GASKET 27-90484-1	S610334021040 CYLINDER COVER GASKET 27-96278	S610334021041 SEALER ROSEGASKET N.A.
			
S610334021042 CYLINDER BLOCK COVER 27-95185-3	S610334021043 CYLINDER COVER 27-72142-1	S610334021044 CYLINDER COVER 27-85653-1	S610334021045 CYLINDER GASKET N.A.
			
S610334021046 THERMO GASKET 27-812867-2	S610334021047 COVER GASKET N.A.	S610334021048 COVER GASKET N.A.	S610334021050 COVER GASKET 27-64859
			
S610334021051 COVER GASKET 27-85498-1	S610334021052 COVER GASKET 27-73665	S610334021053 COVER GASKET 27-85496-1	S610334021054 COVER GASKET 27-76952
			
S610334021056 COVER GASKET N.A.	S610334021057 COVER GASKET N.A.	S610334021058 CYLINDER COVER GASKET N.A.	S610334021059 CYLINDER COVER GASKET N.A.

MERCURY

MERCURY

CUSTOMER SERVICE - SERVIZIO CLIENTI: info@athena-ad.com

CUSTOMER SERVICE - SERVIZIO CLIENTI: info@athena-ad.com

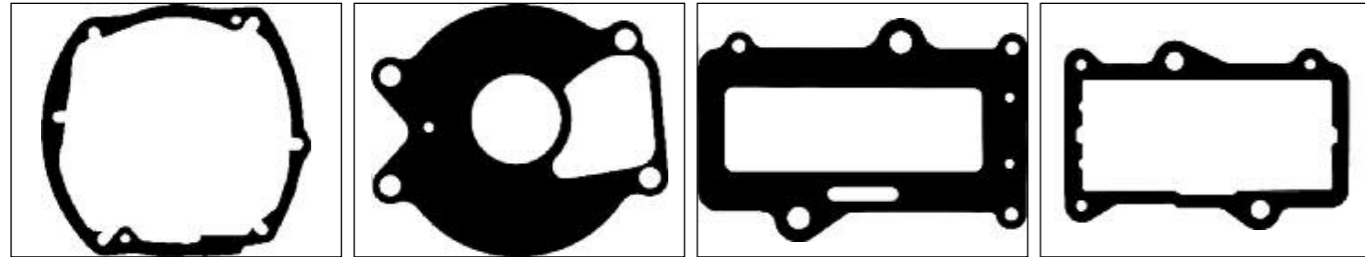

S610334021060 CYLINDER COVER GASKET N.A.
S610334021061 CYLINDER COVER 27-85087
S610334021062 CYLINDER COVER 27-41418-1
S610334021063 CYLINDER COVER 27-41417-2



S610334021064 RUBBER GASKET N.A.
S610334021065 RUBBER GASKET N.A.
S610334021066 RUBBER GASKET N.A.
S610334021067 RUBBER GASKET N.A.

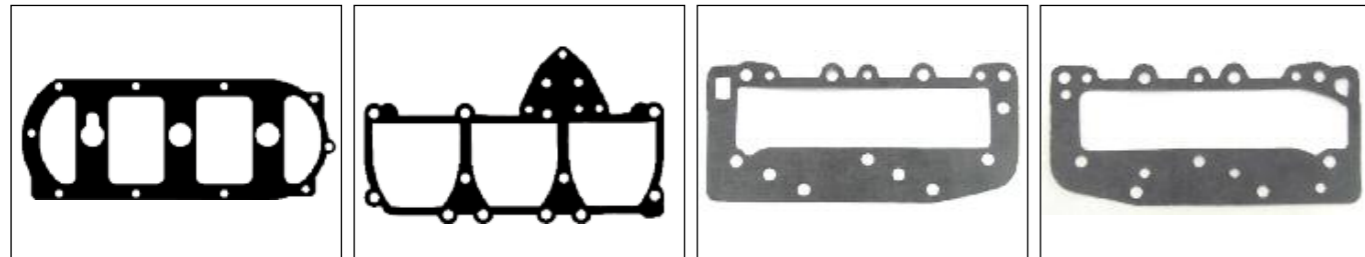

S610334021068 COVER COVER 27-43779-2
S610334021069 CYLINDER COVER GASKET 27-76862-1
S610334021070 BAFFLE GASKET 27-85488-2
S610334021071 BAFFLE GASKET 27-85489-2



S610334021072 BLOCK COVER GASKET 27-85490-2
S610334021075 COVER GASKET N.A.
S610334021076 COVER GASKET N.A.
S610334021077 ADAPTOR PLATE GASKET 27-892320

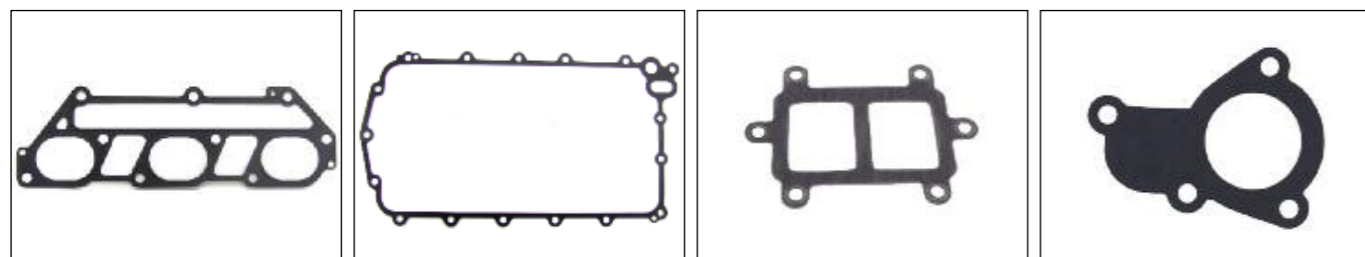

S610334021078 THROTTLE BODY GASKET 27-887893
S610334021079 COVER GASKET 27-887825
S610334021080 MEGAPHONE GASKET 27-78246-1
S610334021081 THERMOSTAT GASKET 27-827284

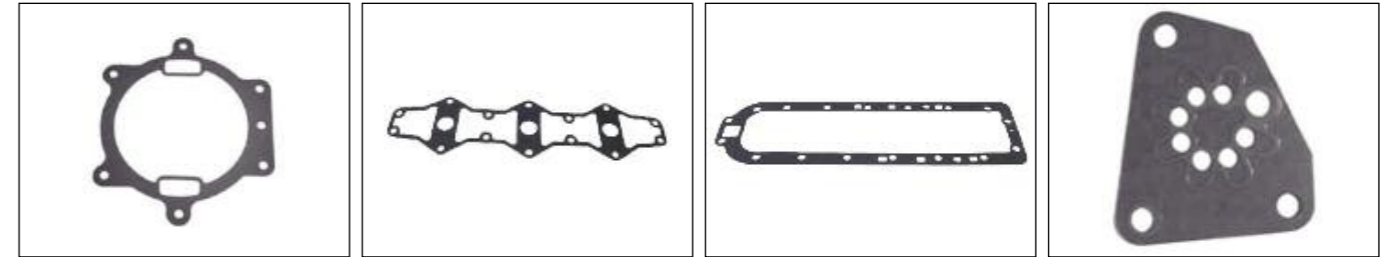

S610334021082 EXPANSION CHAMBER GASKET 27-880738
S610334021083 WATER JACKET HEAD COVER GASKET 27-65788
S610334021084 DIVIDER PLATE GASKET 27-76636
S610334021085 OIL PUMP MOUNT GASKET 27-856452



S610334024001 WATER PUMP GASKET 327674
S610334024002 WATER PUMP GASKET 27-820490
S610334024003 WATER PUMP GASKET N.A.
S610334024004 WATER PUMP GASKET 27-85609-1

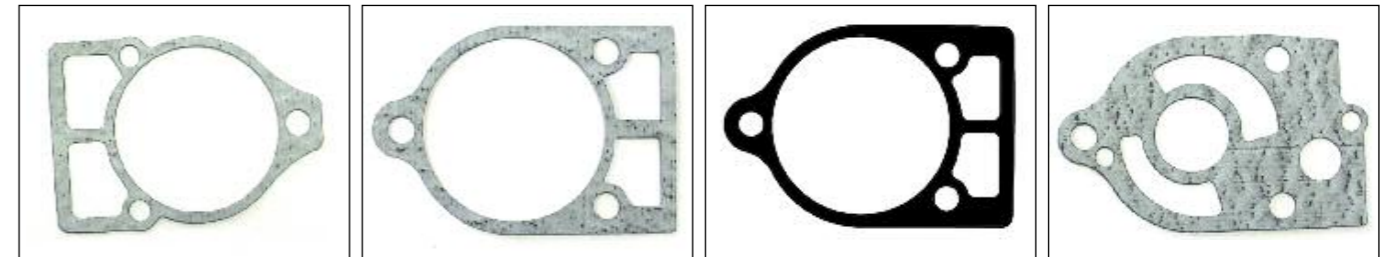

S610334024005 WATER PUMP GASKET 27-85610-1
S610334024006 WATER PUMP GASKET 27-77417
S610334024007 WATER PUMP GASKET N.A.
S610334024008 WATER PUMP GASKET 27-32769



S610334024009 WATER PUMP GASKET 27-32770
S610334024010 WATER PUMP GASKET 27-19206-1
S610334024011 COOLING GASKET 14479
S610334024012 COOLING GASKET 64877

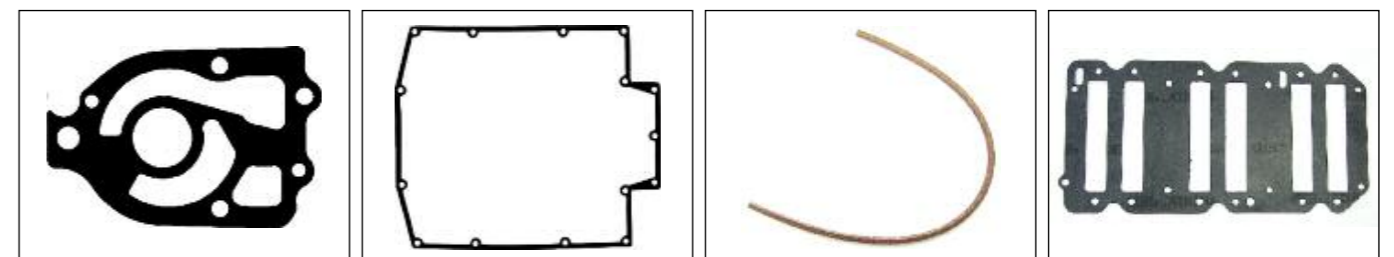

S610334024013 COOLING GASKET 27-85608-1
S610334047001 ALTERNATOR GASKET 27-16737-1
S610334047002 CORK GASKET 27-11338
S610334047003 REED BLOCK GASKET 27-81359

MERCURY

MERCURY

CUSTOMER SERVICE - SERVIZIO CLIENTI: info@athena-ad.com

CUSTOMER SERVICE - SERVIZIO CLIENTI: info@athena-ad.com



S610334047004
REED BLOCK GASKET
27-146972



S610334047005
PORT COVER GASKET
27-F40223

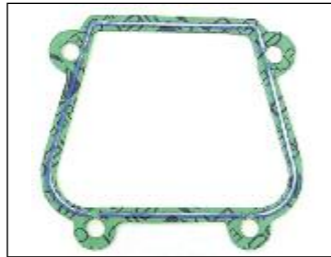

S610334047006
PORT COVER GASKET
N.A.

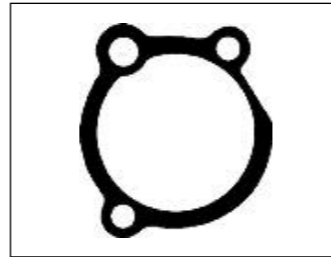

S610334047007
CARTER GASKET
N.A.

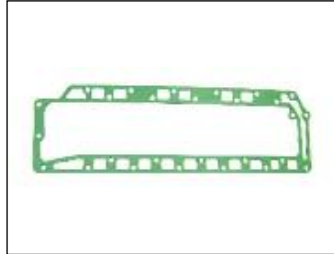

S610334047008
CARTER GASKET
27-F372154-1



S610334047009
REED BLOCK GASKET
27-13937-6

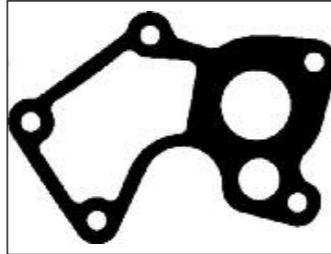

S610334047010
THERMOSTAT GASKET
N.A.

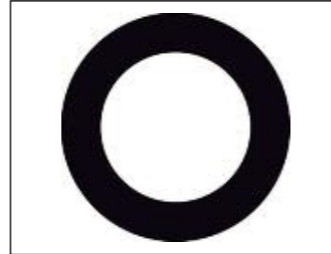

S610334047011
THERMOSTAT GASKET
N.A.

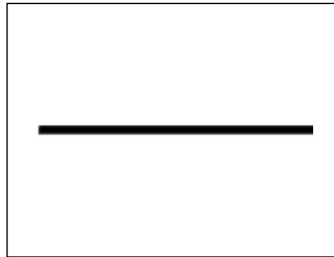

S610334047012
CYLINDER BLOCK GASKET
N.A.

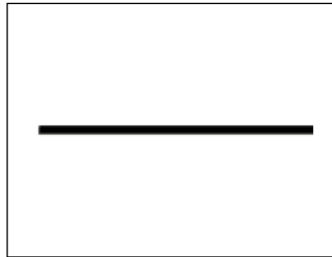

S610334047013
CORK GASKET
N.A.

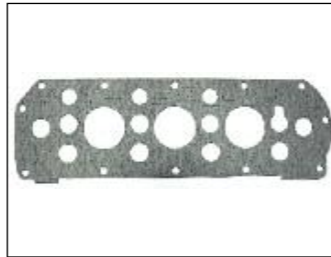

S610334047014
CYLINDER BLOCK GASKET
27-96171-1

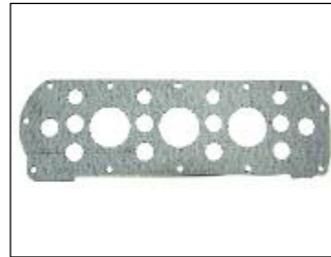

S610334047015
CYLINDER BLOCK GASKET
27-85493

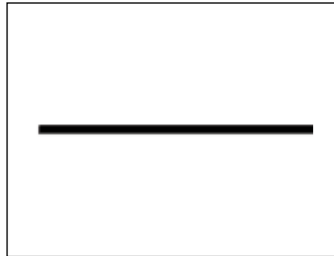

S610334047016
CORK GASKET
N.A.



S610334047017
RUBBER WASHER 19x28,5x8
SUB-184354

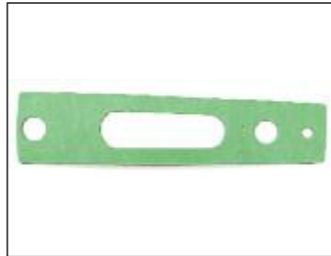

S610334047018
CARTER GASKET
N.A.

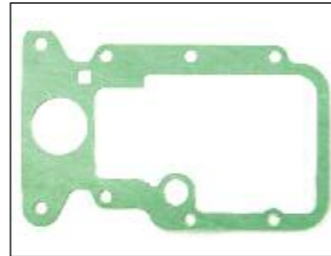

S610334047019
CARTER GASKET
27-F40279-1

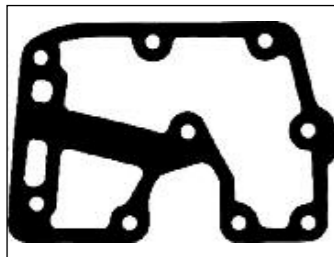

S610334047020
COVER GASKET
27-41499-5

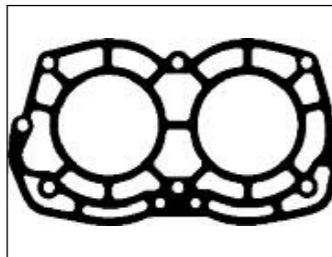

S610334047021
CYLINDER GASKET
N.A.

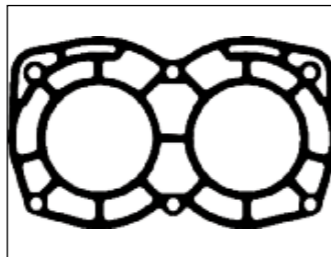

S610334047022
COVER GASKET
N.A.

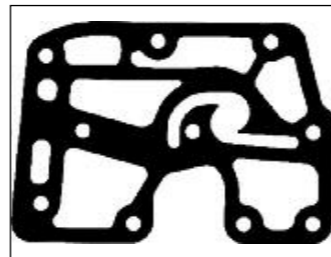

S610334047023
CYLINDER GASKET
27-41499-1

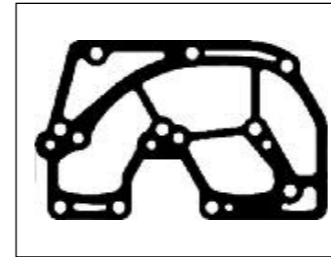

S610334047024
CYLINDER GASKET
27-41475-8

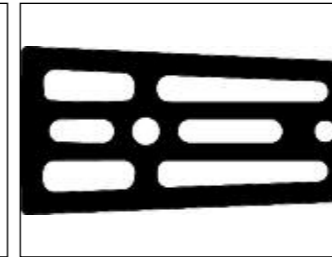

S610334047025
CYLINDER GASKET
27-14621

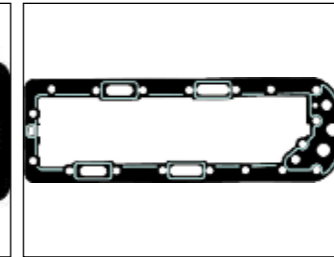

S610334047027
DIVIDER PLATE GASKET
27-847525-1

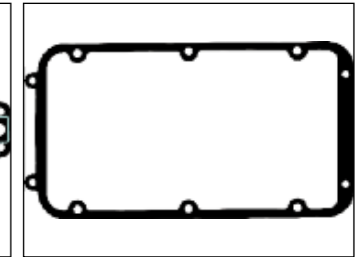

S610334047028
CYLINDER GASKET
27-993163

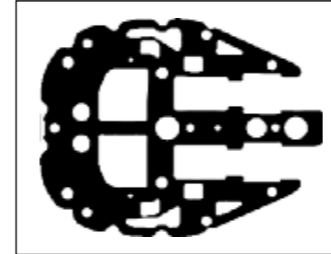

S610334047029
DRIVE SHAFT PLATE
27-75789

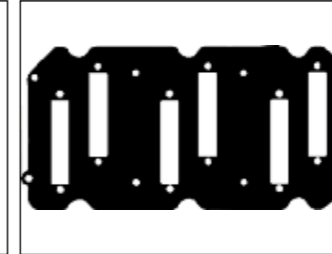

S610334047030
REED BLOCK
27-96761

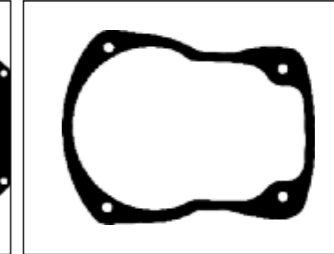

S610334047031
COVER GASKET
N.A.

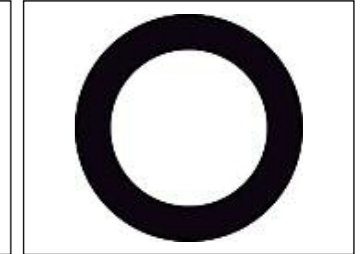

S610334047032
WASHER
SUB-184354

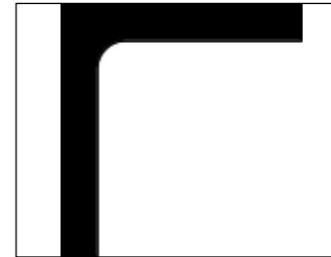

S610334047033
ADESIVE GASKET
N.A.



S610334047034
ADESIVE GASKET
5x5x503mm



S610334047035
ADESIVE GASKET
5x5x291mm



S610334047036
ADESIVE GASKET
5x5x524mm



S610334047037
CORK GASKET
27-814754

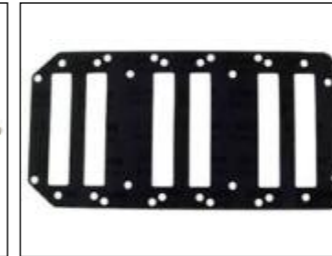

S610334047038
REED BLOCK GASKET
27-840484

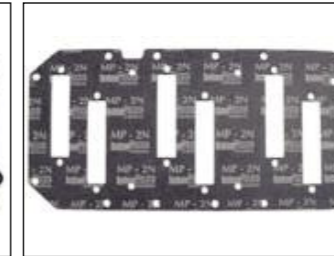

S610334047039
REED BLOCK GASKET
27-146973

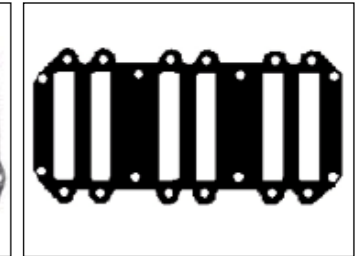

S610334047040
REED BLOCK GASKET
27-12775-5

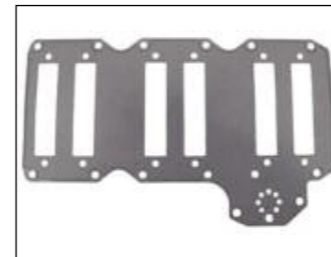

S610334047041
REED BLOCK GASKET
27-834828

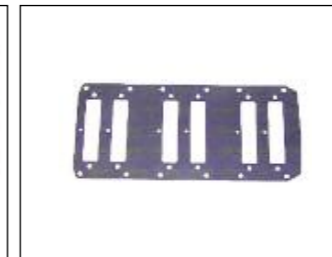

S610334047042
REED BLOCK GASKET
27-850283



S610334047043
DOWNDRAFT GASKET
27-850292



S610334047044
REED BLOCK GASKET
27-850282

MERCURY

MERCURY

CUSTOMER SERVICE - SERVIZIO CLIENTI: info@athena-ad.com

CUSTOMER SERVICE - SERVIZIO CLIENTI: info@athena-ad.com

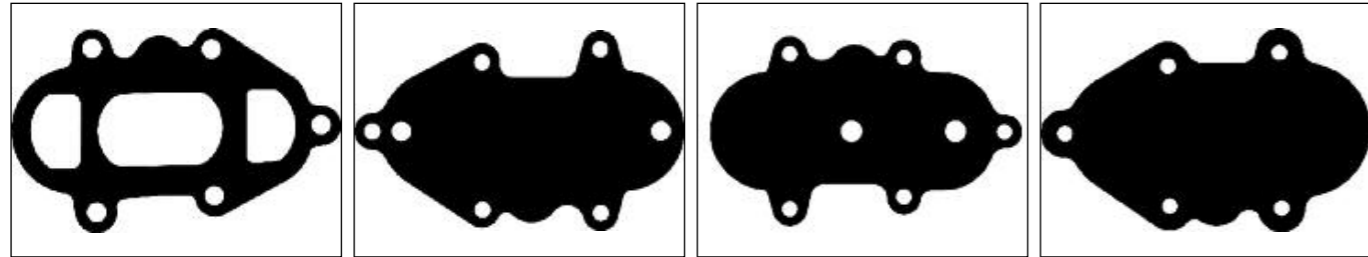

S610334086001
FUEL PUMP GASKET
SUB-187813

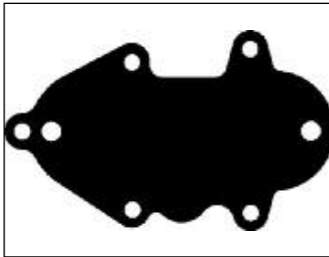

S610334086002
FUEL PUMP GASKET
SUB-187813

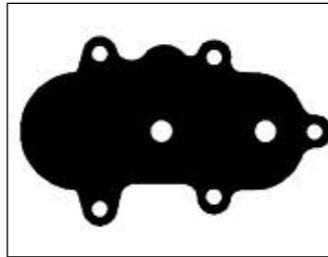

S610334086003
FUEL PUMP GASKET
SUB-187813

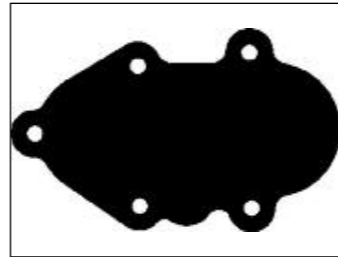

S610334086004
FUEL PUMP GASKET
SUB-187813



S610334086005
FUEL PUMP GASKET
SUB-187807



S610334086006
FUEL PUMP GASKET
SUB-187807

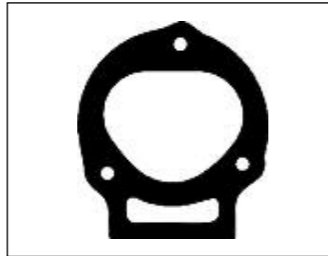

S610334086007
FUEL PUMP GASKET
SUB-187804

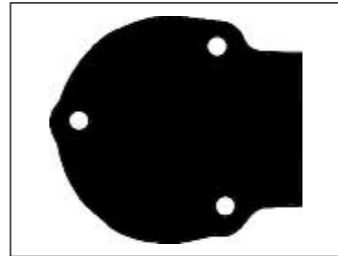

S610334086008
FUEL PUMP GASKET
SUB-187804

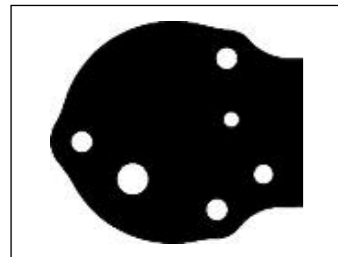

S610334086009
FUEL PUMP GASKET
SUB-187804



S610334086010
FUEL PUMP GASKET
SUB-187808

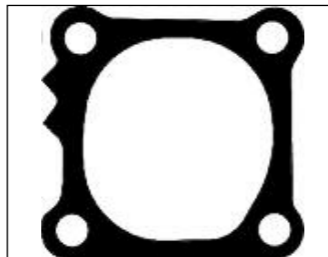

S610334086011
FUEL PUMP GASKET
SUB-187803

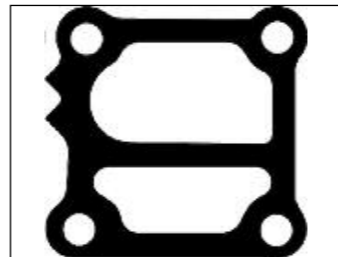

S610334086012
FUEL PUMP GASKET
SUB-187803

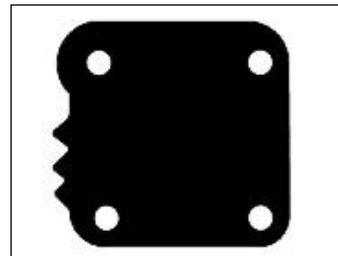

S610334086013
FUEL PUMP GASKET
SUB-187803



S610334086014
FUEL PUMP GASKET
SUB-187809

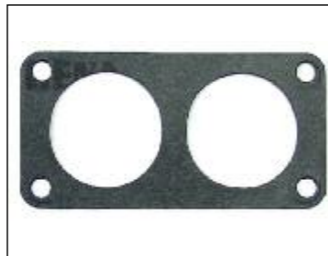

S610334093001
CARBURETOR GASKET
27-67751-1

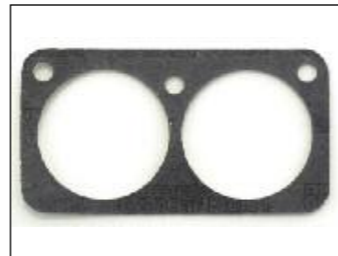

S610334093002
CARBURETOR GASKET
27-89221-1



S610334093003
CARBURETOR GASKET
27-F476067



S610334093004
CARBURETOR ADAPTOR
27-F85168-2

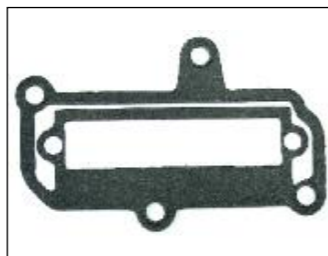

S610334093005
CARBURETOR FLANGE
27-819733

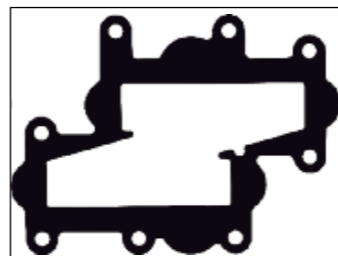

S610334093006
CARBURETOR ADAPTOR
27-178168-1



S610334093007
CARBURETOR GASKET
27-88004

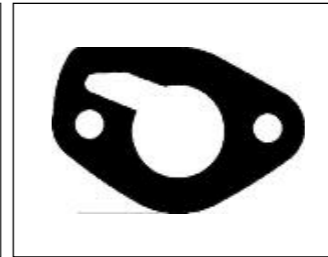

S610334093008
CARBURETOR GASKET
27-14318-2



S610334093009
CARBURETOR GASKET
N.A.

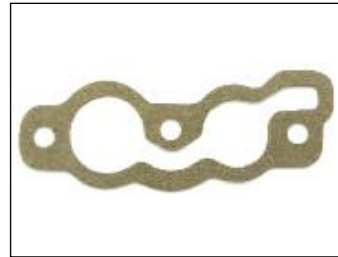

S610334093010
CARBURETOR GASKET
N.A.



S610334108001
FLANGE GASKET
325092

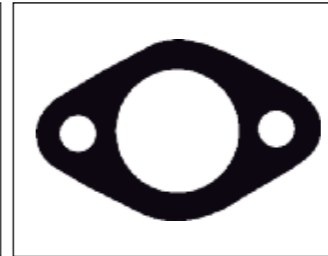

S610334108002
FLANGE GASKET
N.A.

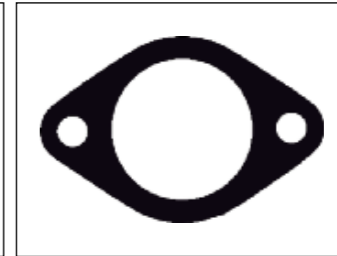

S610334108003
FLANGE GASKET
N.A.

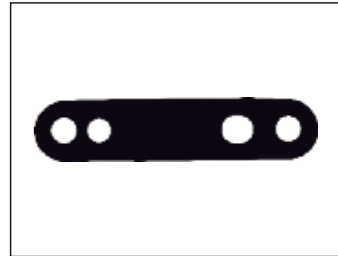

S610334108004
FLANGE GASKET
27-98769-1



S610334108005
FLANGE GASKET
N.A.



S610334108006
CARBURETOR FLANGE
27-48164-1



S610334108007
FLANGE GASKET
27-75791-1



S610334108008
CARBURETOR FLANGE
27-79797-1



S610334108009
CARBURETOR FLANGE
27-73377-1

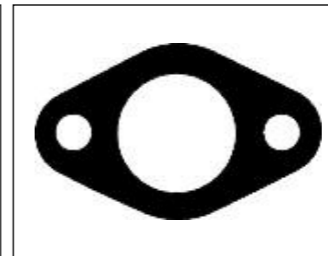

S610334108010
CARBURETOR FLANGE
N.A.



S610334108011
CARBURETOR FLANGE
N.A.

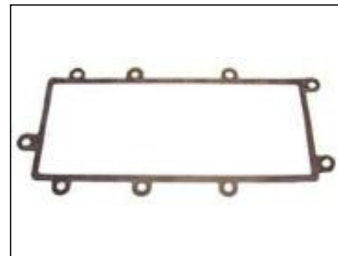

S610334140001
AIR SILENCER GASKET
27-879843



S610334150001
THERMOSTAT GASKET
27-66847

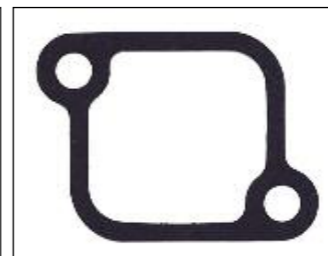

S610334150002
THERMOSTAT GASKET
27-850318-1



S610334150003
THERMOSTAT GASKET
27-879855

MERCURY

MERCURY

CUSTOMER SERVICE - SERVIZIO CLIENTI: info@athena-ad.com

CUSTOMER SERVICE - SERVIZIO CLIENTI: info@athena-ad.com

APPLICATIONS APPLICAZIONI	YEAR ANNO	GASKET KIT KIT G.NI MOTORE	TOP-END GASKET KIT KIT G.NI SMERIGLIO	OIL SEAL KIT KIT PARAOLIO	HEAD GASKET G.NE TESTA CILINDRO	BASE GASKET G.NE BASE CILINDRO	NOTE
40-50 HP	ALL	P600393850001	N/P	P600393400001	S610393001001	S610393006001	
60-70 HP	ALL	P600393850002	N/P	-	S610393001002	S610393006002	
90 HP	ALL	P600393850003	N/P	-	S610393001003	S610393006003	

GASKET KIT - KIT GUARNIZIONI



P600393400001

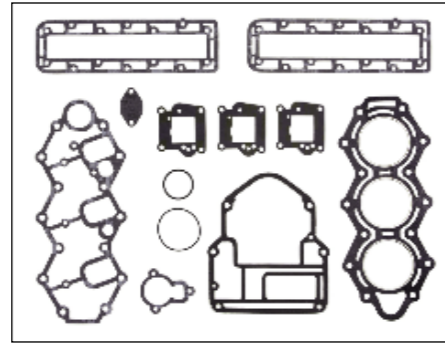

P600393850001

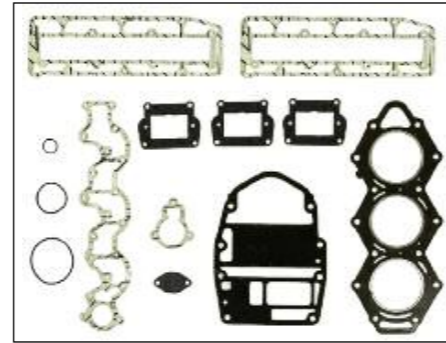

P600393850002

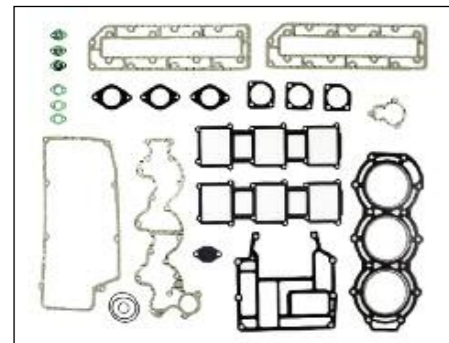

P600393850003

HEAD GASKET - GUARNIZIONI TESTA CILINDRO

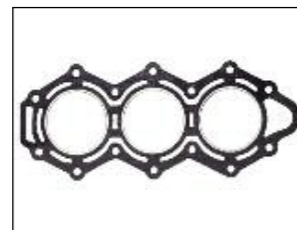

S610393001001
3C8-01005-4



S610393001002
3F3-01005-0



S610393001003
3T9-01005-0

BASE GASKET - GUARNIZIONI BASE CILINDRO

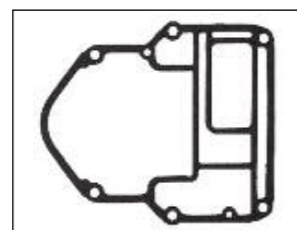

S610393006001
3C8-01303-1



S610393006002
3F3-01303-1

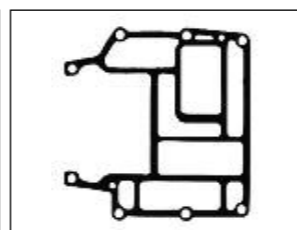

S610393006003
3B7-01303-0

INDIVIDUAL GASKET
GUARNIZIONI SFUSE

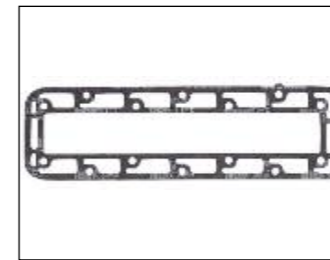

S610393003001
EXHAUST COVER GASKET
3C8-02305-0

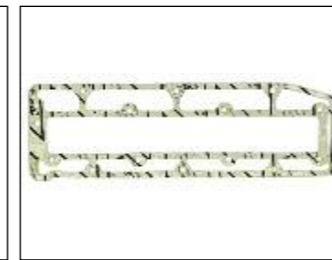

S610393003002
EXHAUST COVER GASKET
3F3-02305-1

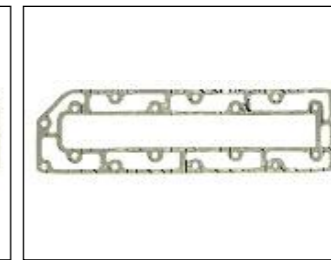

S610393003003
EXHAUST COVER GASKET
3B7-02305-1

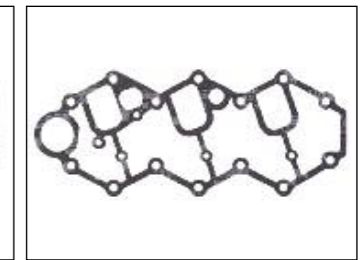

S610393015001
CYLINDER HEAD COVER GASKET
3C8-01024-0

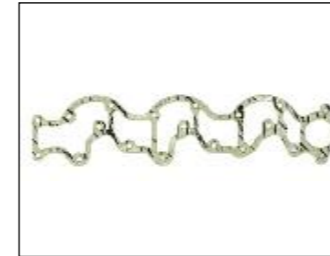

S610393015002
CYLINDER HEAD COVER GASKET
3F3-01024-0

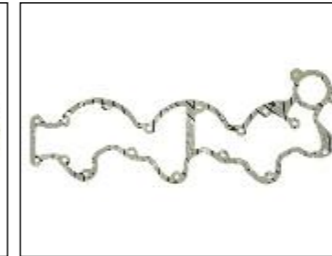

S610393015003
CYLINDER HEAD COVER GASKET
3T9-01024-0



S610393021001
BLIND PLATE GASKET
3C8-09082-0

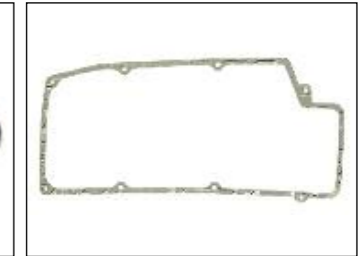

S610393047001
COVER GASKET



S610393058001



S610393058002

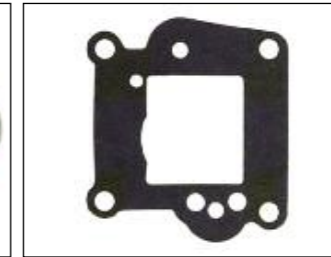

S610393082001
REED VALVE GASKET
3C8-02104-0



S610393082002
REED VALVE GASKET
3F3-02104-0

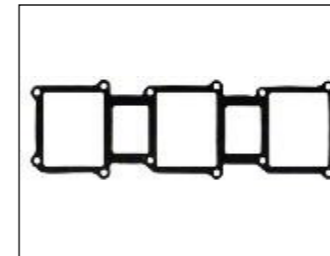

S610393082003
REED VALVE GASKET
3T9-02104-0

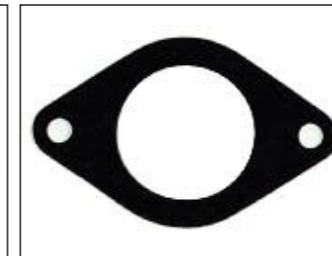

S610393108001
MANIFOLD GASKET

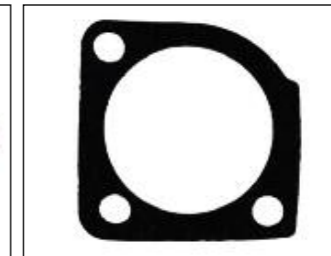

S610393108002
MANIFOLD GASKET



S610393150001
THERMOSTAT GASKET
3T9-01032-0

APPLICATIONS APPLICAZIONI	YEAR ANNO	SPECIFICATION SPECIFICHE	CYL CIL	GASKET KIT KIT G.NI MOTORE	HEAD GASKET G.NE TESTA CILINDRO	BASE GASKET G.NE BASE CILINDRO	OIL SEAL KIT KIT PARAOLIO	NOTE
8 HP	1997-2005		2	P600485850026	-	-	P600485400026	P600485400026 - OIL SEAL FOR LOWER UNIT
9.9-15 HP	1984-1997		2	P600485850013	S610485001022	S610485006014	P600485400013	
9.9-15 HP	1997-2005	4 Stroke	2	P600485850010	S610485001021	S610485006013	P600485400010	
15 HP	1998-2005	F15	2	P600485850014	-	-	P600485400014	P600485400014 - OIL SEAL FOR LOWER UNIT
15 HP	2001-2004	4 Stroke	2	P600485850019	S610485001026	S610485006017	P600485400019	
25-30 HP	1984-1992		2	P600485850024	S610485001027	-	P600485400024	
25 HP	1988-1994		2	P600485850024	S610485001027	-	P600485400024	
25 HP	1996-1999		3	P600485850016	S610485001024	S610485006016	P600485400016	
25 HP	1998-2000	F25	3	P600485850011	-	-	P600485400011	P600485400011 - OIL SEAL FOR LOWER UNIT
30 HP	1987-1993		3	P600485850016	S610485001024	S610485006016	P600485400016	
30 HP	1993-1997	C30	3	P600485850023	-	-	P600485400023	P600485400023 - OIL SEAL FOR LOWER UNIT
30 HP	1997	C30HD	3	P600485850017	S610485001025	-	P600485400017	
30-40 HP	2000-2004	4 Stroke	3	P600485850015	S610485001023	S610485006015	-	KIT WITHOUT OIL SEAL
40 HP	1984-UP		3	P600485850001	S610485001018	S610485006009	P600485400001	
40 HP	1992-UP		3	P600485850001	S610485001018	S610485006009	P600485400001	
40 HP	1994-1997	C40	2	P600485850025	P600485850008	S610485001028<	P600485400025 P600485400008	P600485400008 - OIL SEAL FOR LOWER UNIT
40 HP	1997-2002	C40	3	P600485850018	-	-	P600485400018	P600485400018 - OIL SEAL FOR LOWER UNIT
40 HP	1998	P40	3	P600485850018	-	-	P600485400018	P600485400018 - OIL SEAL FOR LOWER UNIT
40 HP	2000-2001	F40	3	P600485850021	-	-	P600485400021	P600485400021 - OIL SEAL FOR LOWER UNIT
40/50 HP	1984		3	P600485850001	S610485001018	S610485006009	P600485400001	
40-50 HP	1995-UP		3	P600485400020 P600485400018	S610485001037	S610485006009	P600485400020 P600485400018	P600485400018 - OIL SEAL FOR LOWER UNIT
50 HP	1984-1995	PRO 50/50 (6H5)	3	P600485850001	S610485001018	S610485006009	P600485400001	
50 HP	1995-1996	P50	3	P600485850018	-	-	P600485400018	P600485400018 - OIL SEAL FOR LOWER UNIT
50 HP	1999-2001	C50	3	P600485850018	-	-	P600485400018	P600485400018 - OIL SEAL FOR LOWER UNIT
60/70 HP	1984-1998		3	P600485850002	S610485001016	S610485012046	P600485400002	
75,85 & 90 HP	1984-UP	90 (6HI)	3	P600485850006	S610485001010	S610485012045	P600485400006	
75,85 & 90 HP	1994-UP		3	P600485850006	S610485001010	S610485012045	P600485400006	
75-115 HP	2000-UP	4 Stroke	4	-	S610485001033	S610485006021	-	
115 HP	1986-UP		V4	P600485850005	S610245001006	S610334015003	P600485400003	
130 HP	1988-UP		V4	P600485850005	S610245001006	S610334015003	P600485400003	
150/175/200 HP	2000-UP	2.6 L 90° Block HPDI	V6	P600485850007	S610485001020	S610485006010	-	KIT WITHOUT OIL SEAL
150-200 HP	1999-UP	2.6 L 90° Block EFI	V6	-	S610245001008	S610334015003	-	
150 HP	1984-2002	C150	V6	S610245001008	S610334015003	-	-	
150 HP	1999	150 DX, LX, SX	V6	P600485850004	S610485001019	S610485012044	P600485400004	
150 HP	2001-2002	150 SX	V6	-	S610245001008	S610334015003	-	
150 HP	2000	150 VX	V6	P600485850004	S610485001019	S610485012044	P600485400004	

APPLICATIONS APPLICAZIONI	YEAR ANNO	SPECIFICATION SPECIFICHE	CYL CIL	GASKET KIT KIT G.NI MOTORE	HEAD GASKET G.NE TESTA CILINDRO	BASE GASKET G.NE BASE CILINDRO	OIL SEAL KIT KIT PARAOLIO	NOTE
150 HP	2004-UP	150 F, LF	4	-	S610485001038	S610485006020	-	
175 HP	1984-1999		V6	-	S610245001008	S610334015003	-	
150-225 HP	1984-1998	90°	V6	P600485850003	S610245001008	S610334015003	P600485400003	
225 HP	1987-1989	Excel	V6	P600485850003	S610245001008	S610334015003	P600485400003	
200 HP	1999	LX 200	V6	P600485850004	S610485001019	S610485012044	P600485400004	
200 HP	2002	SX 200	V6	P600485850004	S610485001019	S610485012044	P600485400004	
200 HP	1998-1999	V 200	V6	-	S610485001019	S610485012044	-	
200-225 HP	2002-UP	4 Stroke	V6	-	S610334001018 S610334001019	S610334006025	-	
200-250 HP	2000-UP	3.3 L HPDI	V6	P600485850031	S610485001036	S610485006019	-	KIT WITHOUT OIL SEAL
200,225 HP	1990-92-2001		V6	P600485850004	S610485001019	S610485012044	P600485400004	
225 HP	2000-2001	225 LX	V6	-	S610485001019	S610485012044	-	
225 HP	1994-1996	225 SX	V6	-	S610245001008	S610334015003	-	
225 HP	1997-1999	225 S, L	V6	-	S610485001019	S610485012044	-	
225 HP	1998-1999	225 V	V6	-	S610485001019	S610485012044	-	
250 HP	1997-1999	250 S, L	V6	-	S610485001019	S610485012044	-	
225, 250 HP	2000-2001	225, 250 LX	V6	-	S610485001019	S610485012044	-	
250 HP	1992-UP	250 L(61A), 250(61B)	V6	-	S610485001019	S610485012044	-	
200, 225, 250 HP			V6	-	S610485001019	S610485012044	-	
300 HP	2004-UP	3.3 L HPDI	V6	P600485850031	S610485001036	S610485006019	-	KIT WITHOUT OIL SEAL

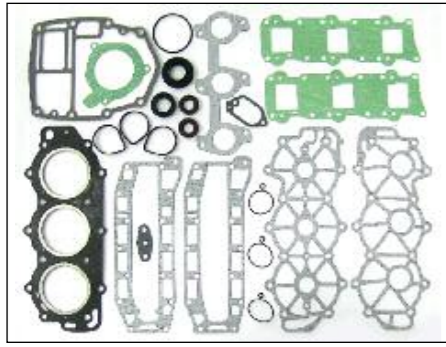

P600485850001
6H4-W0001-A1-00

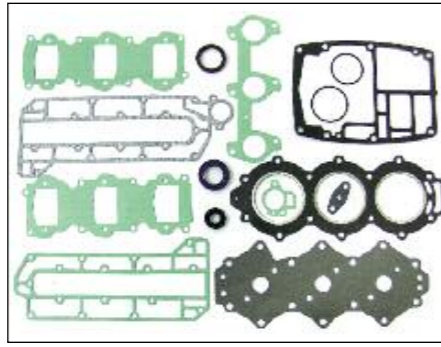

P600485850002
6H3-W0001-00-00

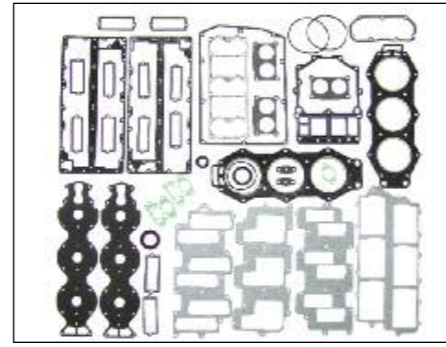

P600485850003
6G5-W0001-03-00

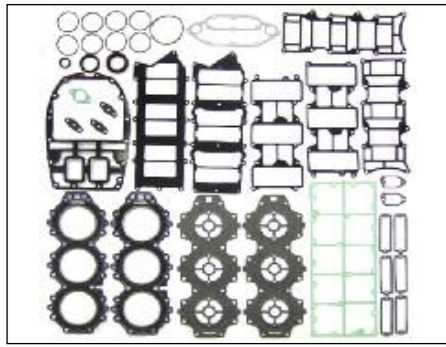

P600485850004
61A-W0001-01-00

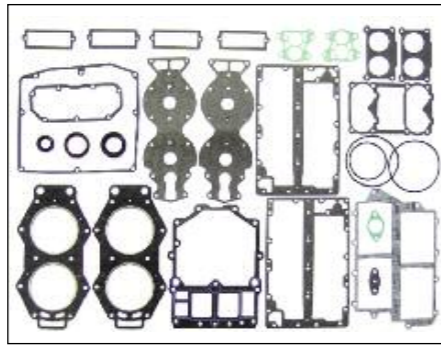

P600485850005
6F3-W0001-A4-00

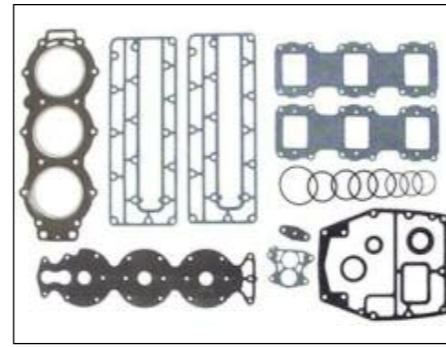

P600485850006
6H1-W0001-00-00
6H1-W0001-A0-00

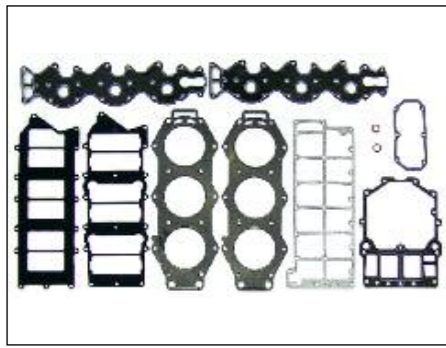

P600485850007
68F-W0001-01-00

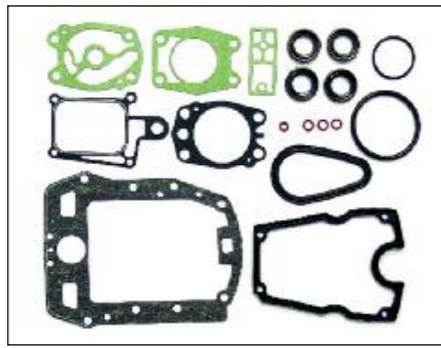

P600485850008
6A0-W0001-21-00

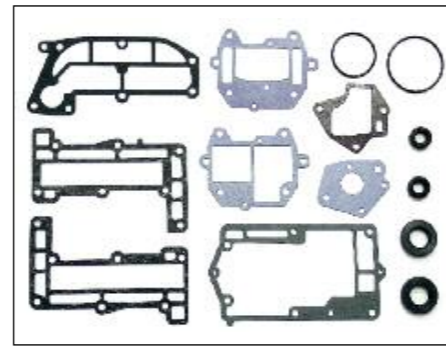

P600485850009
6G1-W0001-A2-00

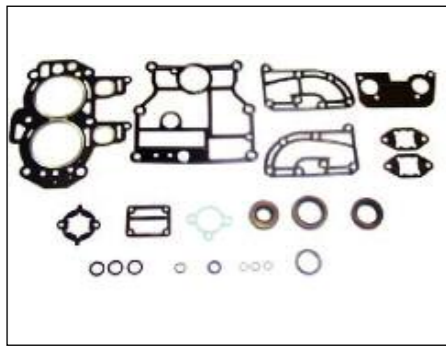

P600485850010
6G8-W0001-A3-00



P600485850011
65W-W0001-20-00

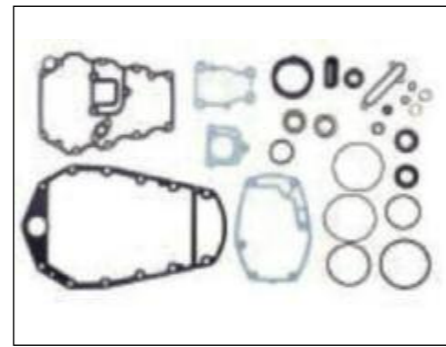

P600485850012
67C-W0001-20-00

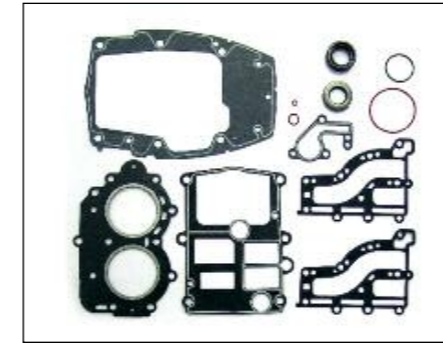

P600485850013
682-W001-06-00

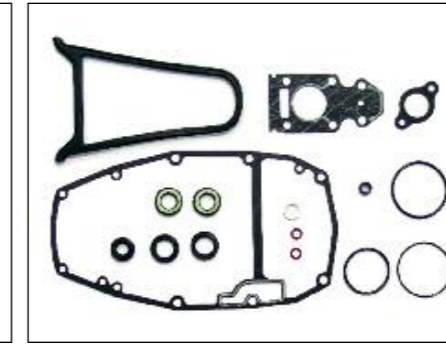

P600485850014
66M-W0001-20-00

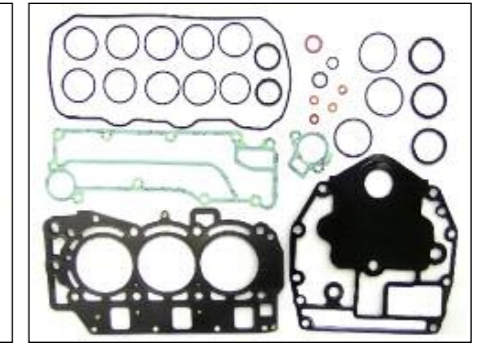

P600485850015
67C-W0001-00-00

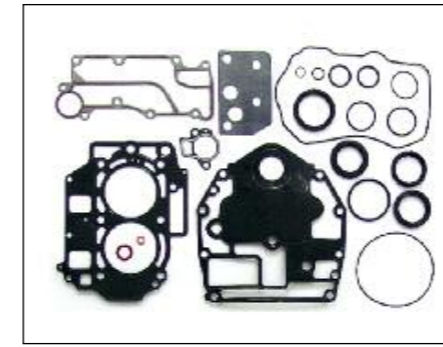

P600485850016
65W-W0001-00-00

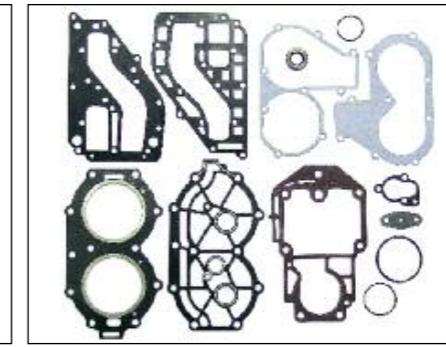

P600485850017
61T-W0001-02-00
689-W0001-04-00

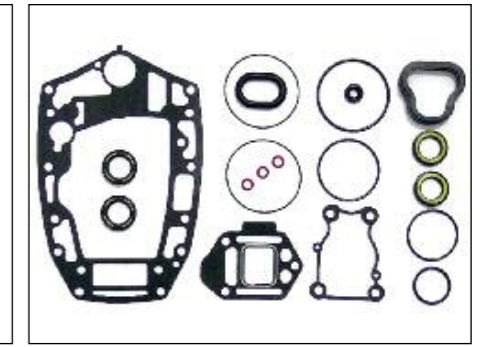

P600485850018
63D-W0001-20-00

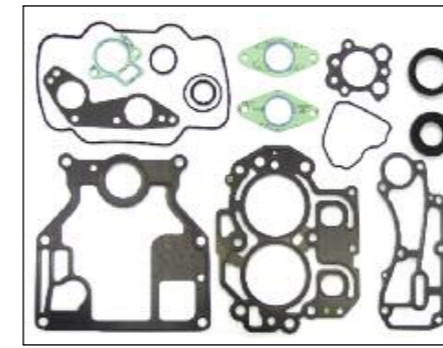

P600485850019
66M-W0001-01-00

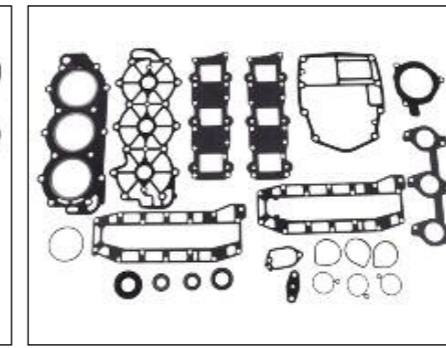

P600485850020
63D-W0001-00-00

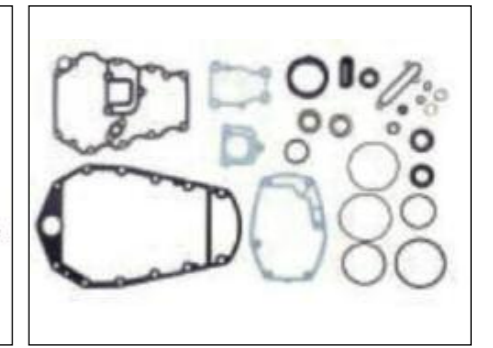

P600485850021
67c-w0001-20-00



P600485850022
6L2-W0001-C3-00

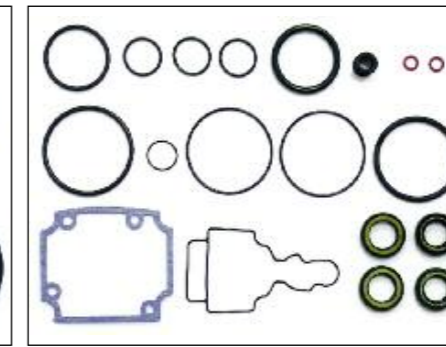

P600485850023
61N-W0001-E1-00



P600485850024
6L2-W0001-03-00
6L2-W0001-02-00

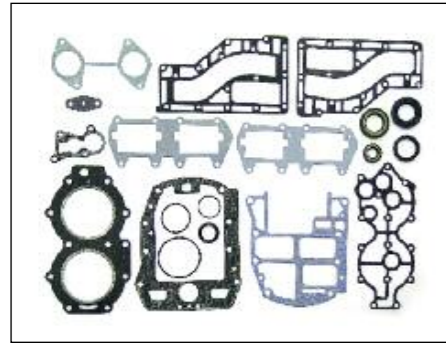

P600485850025
6R6-W0001-02-00



P600485850026
6G1-W0001-C1-00

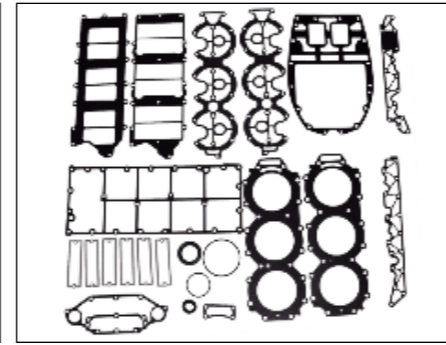

P600485850031
6D0-W0001-00-00

HEAD GASKET
GUARNIZIONI TESTA CILINDRO

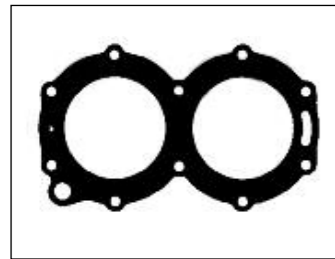

S610485001004
697-11181-A0-00
697-11181-A1-00



S610245001006
6E5-11181-02-00



S610245001008
6G5-11181-A0-00
6G5-11181-00-00



S610485001010
688-11181-A0-00



S610485001016
6H3-11181-01-00
6H3-11181-A1-00



S610485001018
6H4-11181-00-00



S610485001019
61A-11181-A1-00



S610485001020
63F-11181-00-00



S610485001021
6G8-W001-A3-00



S610485001022
6E7-11181-A1-00



S610485001023
67C-11181-01-00



S610485001024
N.A.

HEAD GASKET
GUARNIZIONI TESTA CILINDRO



S610485001025
61N-11181-A1-00



S610485001026
66M-11181-10-00



S610485001027
6L2-11181-A2-00



S610485001028
676-11181-A1-00

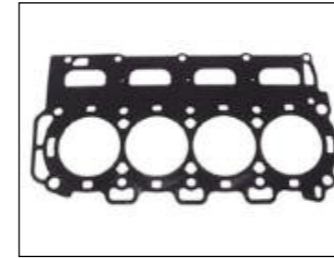

S610485001033
67F-11181-02-00



S610485001036
60V-11181-00-00

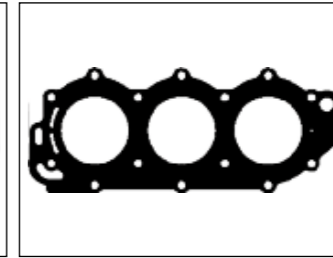

S610485001037
63D-11181-A1-00

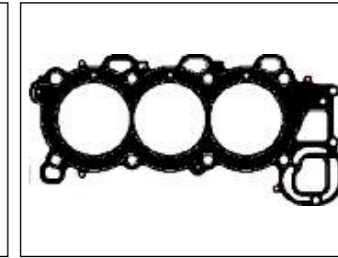

S610334001018
69J-11182-03-00

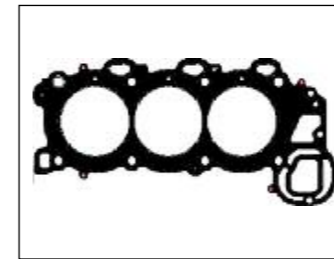

S610334001019
69J-11181-03-00



S610485001038
63P-11181-00

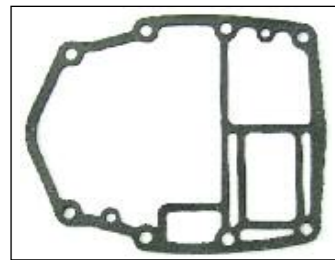

S610485006009
6H4-45113-A0-00

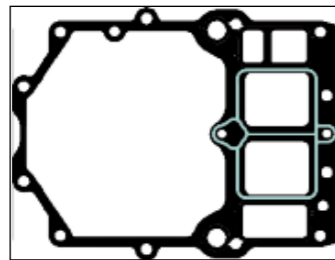

S610485006010
68F-45113-00-00

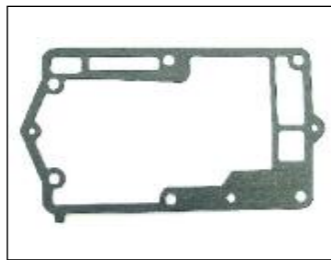

S610485006012
6G1-45113-A1-00

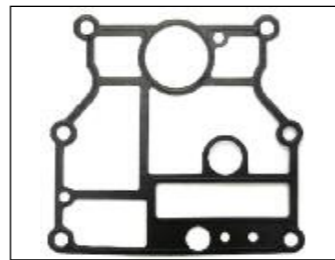

S610485006013
6G8-11351-A0-00



S610485006014
682-11351-A0-00



S610485006015
67C-11351-00-00



S610485006016
65W-11351-00-00



S610485006017
66M-11351-10-00

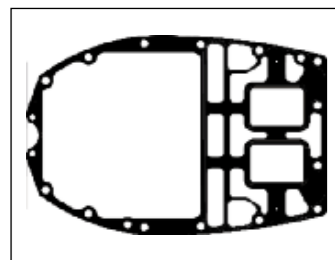

S610485006019
60V-45113-01-00

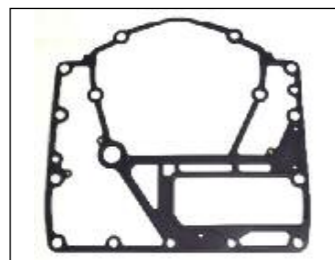

S610485006020
63P-11351-01

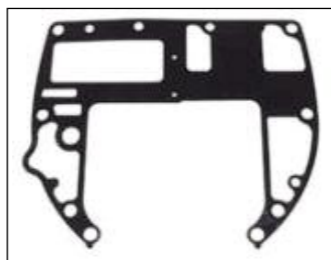

S610485006021
68V-11351-00-00

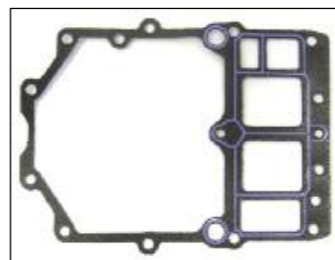

S610334015003
6G5-451130-A0-00

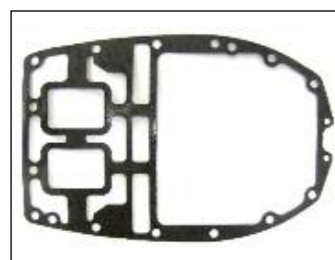

S610485012044
61A-45113-A0-00

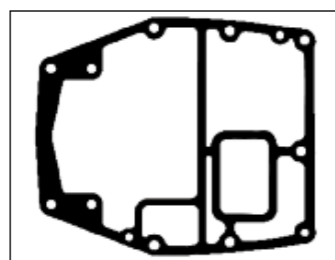

S610485012045
688-45113-00-00

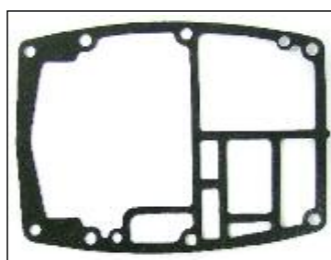

S610485012046
6H3-45113-A0-00

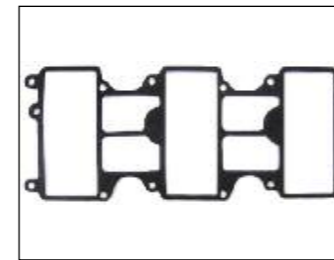

S610485010026
INTAKE GASKET
61A-13646-00-00



S610485010027
REED BLOCK GASKET
64E-13645-A0-00

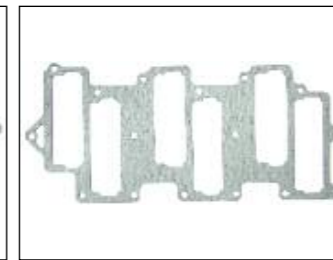

S610485010028
REED GASKET OUTER
6K7-13645-A1-00

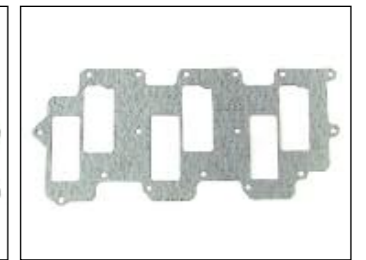

S610485010029
REED GASKET INNER
6K7-13646-A1-00



S610485010030
INTAKE MANIFOLD GASKET
6E5-13645-A1-00

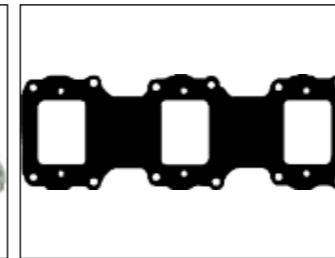

S610485010031
REED BLOCK GASKET
688-13621-A1-00

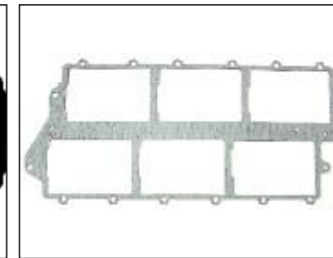

S610485010032
INTAKE MANIFOLD GASKET
6G5-13645-A1-00

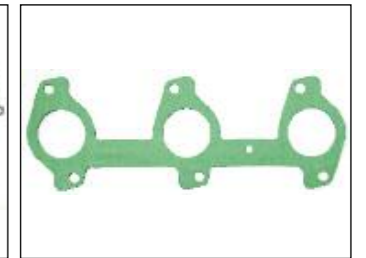

S610485010033
CARB.MOUNT GASKET
6H3-14198-01-00

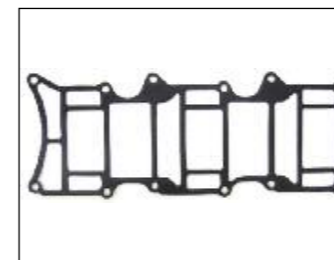

S610485010034
INTAKE GASKET
61A-13645-00-00

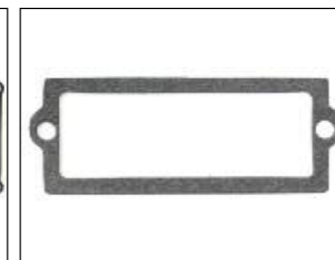

S610485010035
REED BLOCK GASKET
6E5-13621-A1-00



S610485010036
V6 REED GASKET
687-13621-00-00



S610485010037
REED BLOCK GASKET
61A-13621-A0-00

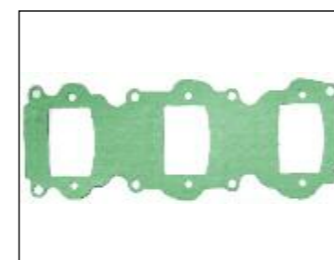

S610485010038
REED BLOCK GASKET
6H3-13622-00-00



S610485010039
POPPET VALVE COVER
6G5-11382-A1-00

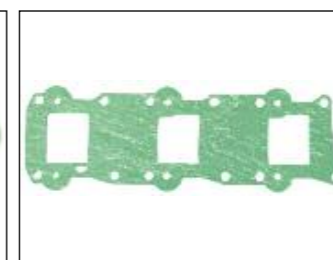

S610485010040
REED BLOCK
6H4-13621-A1-00



S610485010041
INTAKE GASKET
65L-13646-00-00



S610485010042
INTAKE GASKET
65L-13645-00-00



S610485010043
INTAKE GASKET
N.A.



S610485010044
INTAKE GASKET
N.A.



S610485010045
INTAKE GASKET
6G1-13621-A1



S610485010046
INTAKE GASKET
6G1-13645-A1



S610485010047
INTAKE GASKET
6G1-14198-A1



S610485010048
INTAKE GASKET
6G8-13645-00

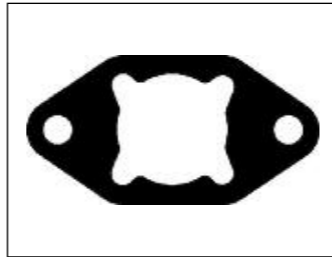

S610485010049
INTAKE GASKET
6G8-13646-A0

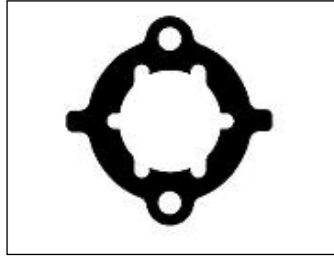

S610485010050
INTAKE GASKET
6G8-14198-A0

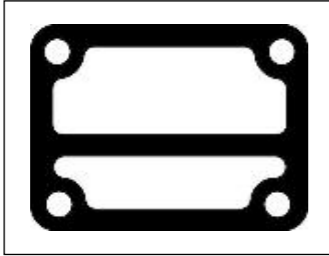

S610485010051
BREATHER GASKET
6G8-15374-00

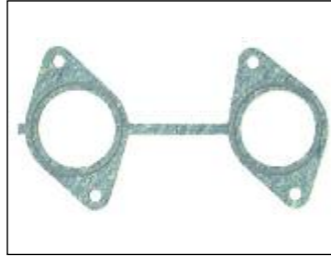

S610485010052
INTAKE GASKET
6E9-14198-A0

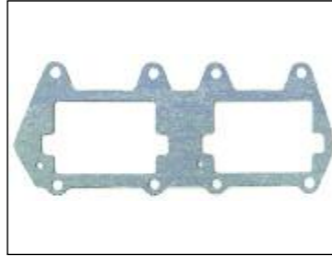

S610485010053
INTAKE GASKET
67613646-A0

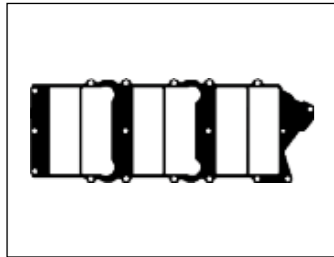

S610485010056
HPDI INNER INTAKE GASKET
N.A.

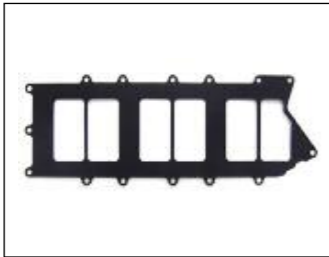

S610485010057
HPDI INNER INTAKE GASKET
60V-13646-00

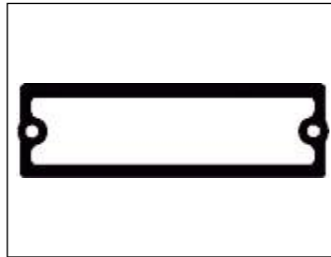

S610485010058
HPDI INNER INTAKE GASKET
60V-13621-A0

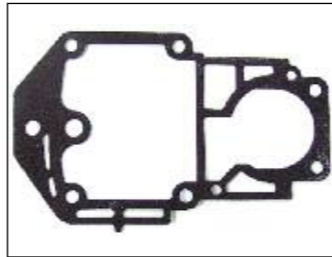

S610485012010
GASKET UPPER CASING
61T-45113-A0

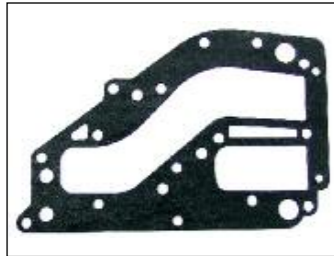

S610485012011
GASKET EXHAUST INNER
6K8-41122-A1

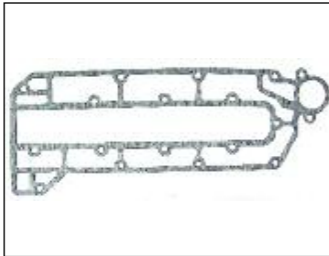

S610485012043
INNER EXHAUST COVER
6H3-41114-A0-00



S610485012047
EXHAUST COVERGASKET
6G5-41112-A1-00

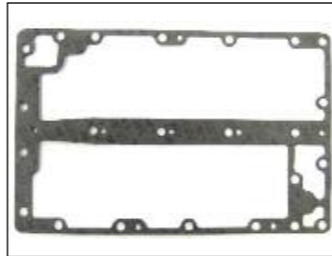

S610485012048
EXHAUST GASKET
6E5-41112-A1-00

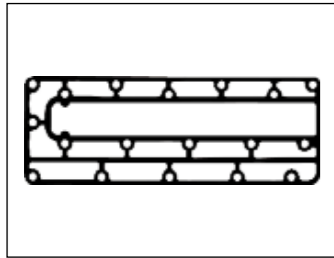

S610485012049
EXHAUST GASKET
6E5-41112-A1-00

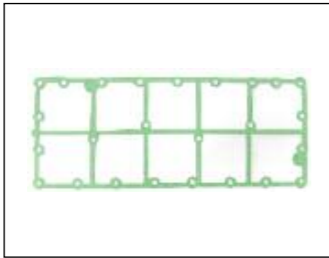

S610485012050
INNER EXHAUST COVER
688-41112-00-00

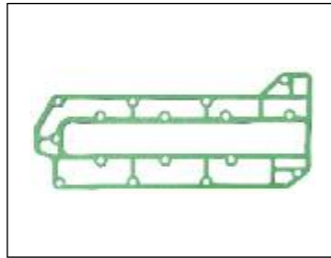

S610485012051
INNER EXHAUST COVER
6H3-41112-A0-00

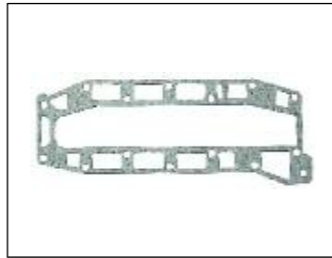

S610485012052
INNER EXHAUST COVER
6H4-41112-A0-00

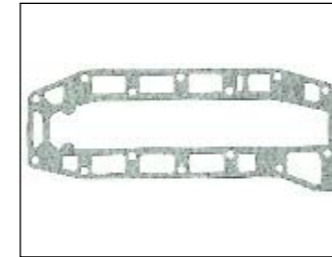

S610485012053
OUTER EXHAUST COVER
6H4-41114-A0-00

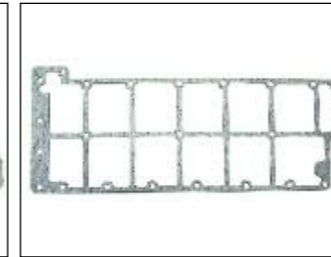

S610485012054
EXHAUST GASKET
68F-41114-00



S610485012055
EXHAUST MAN. GASKET
676-41133-A1



S610485012056
RUBBER EXHAUST GASKET
676-45128-00



S610485012057
RUBBER EXHAUST GASKET
676-45127-00

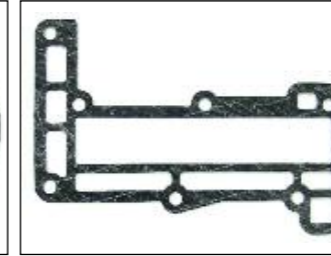

S610485012058
INNER EXHAUST GASKET
6G1-41112-A1

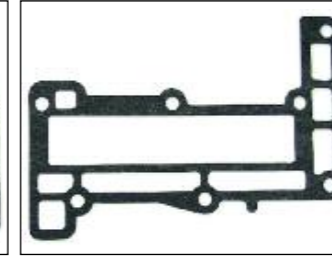

S610485012059
OUTER EXHAUST GASKET
6G1-41114-A0



S610485012060
EXHAUST GASKET
6G1-41133-A0



S610485012061
INNER EXHAUST GASKET
6G8-41112-02



S610485012062
OUTER EXHAUST GASKET
6G8-41114-00



S610485012063
EXHAUST MAN. GASKET
62Y-411133-00

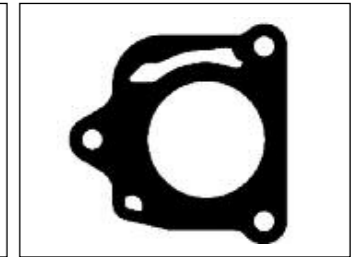

S610485012064
MAN. COVER GASKET
67C-41133-00

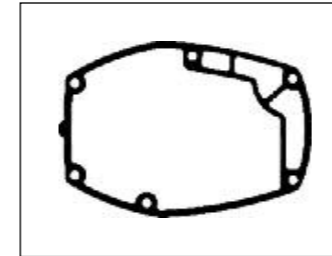

S610485012065
EXHAUST MAN. GASKET
62Y-41134-01



S610485012066
GASKET MUFFLER
67C-45123-00

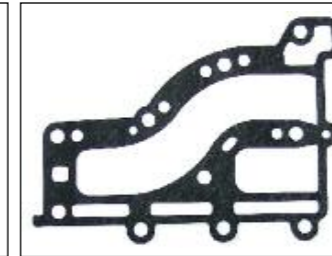

S610485012067
GASKET EXHAUST INNER
682-41112-A1



S610485012068
EXHAUST MAN. GASKET
66M-41133-00

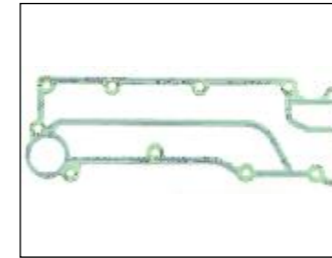

S610485012069
GASKET EXHAUST OUTER
67C-41114-00

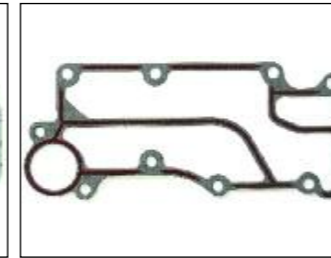

S610485012070
GASKET EXHAUST OUTER
65W-41114-00



S610485012071
EXHAUST MAN. GASKET
6H4-41134-A0



S610485012072
GASKET MUFFLER
63D-45123-00

YAMAHA

YAMAHA

CUSTOMER SERVICE - SERVIZIO CLIENTI: info@athena-ad.com

CUSTOMER SERVICE - SERVIZIO CLIENTI: info@athena-ad.com



S610485012073
EXHAUST GASKET
66M-41114-01



S610485012074
EXHAUST MAN. GASKET
6L2-41134-00

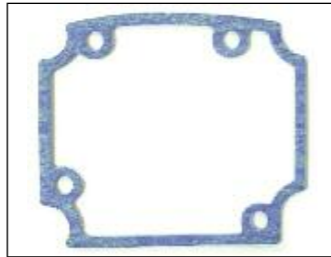

S610485012075
EXHAUST MAN. GASKET
664-41134-A0

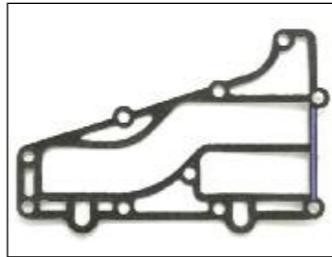

S610485012076
GASKET EXHASUT INNER
6L2-41112-A2

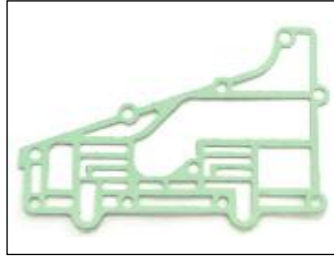

S610485012077
GASKET EXHAUST OUTER
6L2-41114-A1



S610485012078
EXHAUST MAN. GASKET
6L2-41133-A2

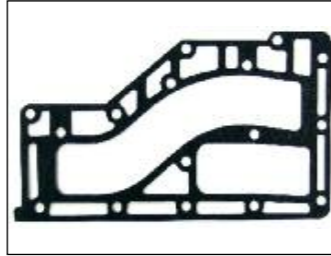

S610485012079
GASKET EXHAUST OUTER
6E9-41114-A0

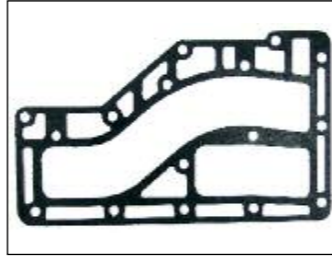

S610485012080
GASKET EXHASUT INNER
676-41112-A0

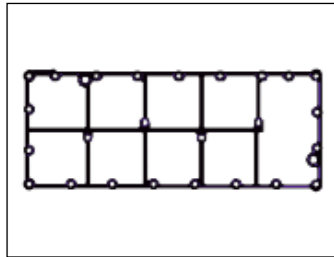

S610485012090
HPDI EXHAUST COVER GASKET
60V-41112-00



S610485015004
HEAD COVERGASKET
61A-11193-A1-00

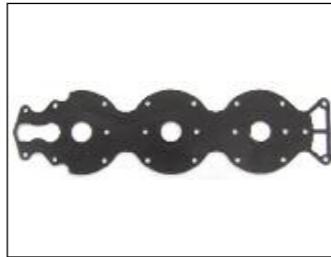

S610485015005
COVERGASKET
6G5-11193-A0-00

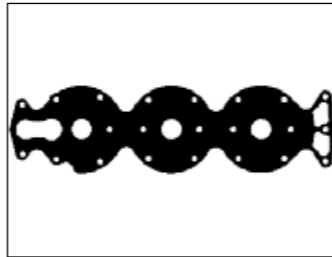

S610485015006
HEAD COVERGASKET
688-11193-01-00

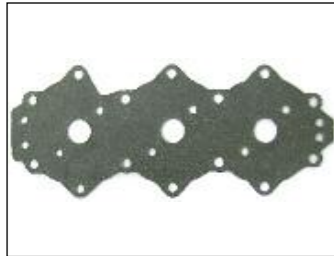

S610485015007
HEAD COVERGASKET
6H3-11193-00-00



S610485015008
HEAD COVER GASKET
68F-11193-01

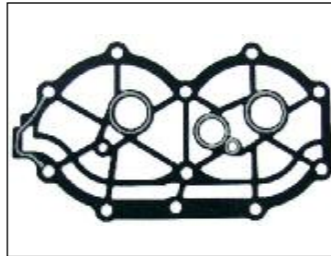

S610485015009
GASKET HEAD COVER
61T-11193-A1

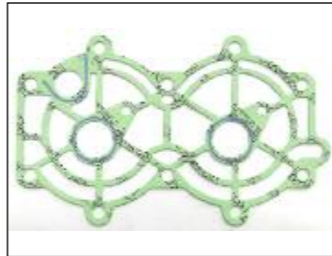

S610485015010
GASKET HEAD COVER
6L2-11193-A1



S610485015011
GASKET VALVE SEAT
6L2-13621-00

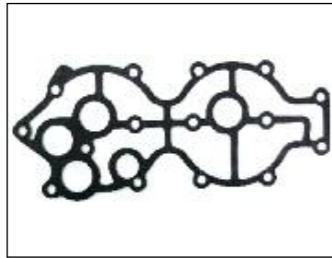

S610485015012
GASKET HEAD COVER
6E9-11193-A0



S610485021008
THERM COVER GASKET
61A-12414-00-00

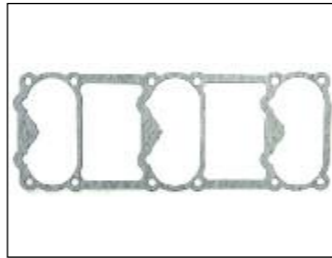

S610485021009
CARB TO AIRBOX
6G5-14483-A1-00

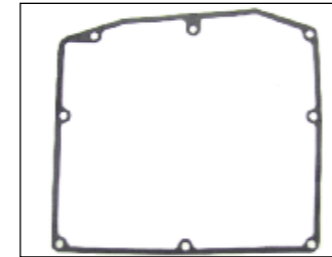

S610485021010
AIR BOX GASKET
6E5-11381-A1-00

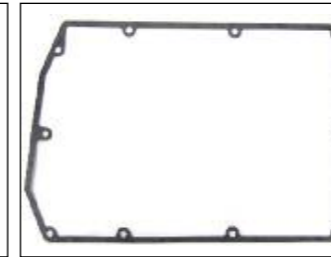

S610485021011
AIR BOX GASKET
6G5-14416-A1-00



S610485021012
THERMO COVER GASKET
688-12414-A1-00



S610485021013
FUEL PUMP GASKET
650-24431-00-00



S610485021014
CARB. MOUNTING GASKET
6E5-14198-A1-00

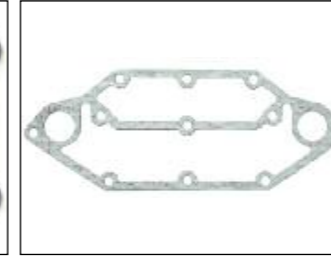

S610485021015
WATER COVER GASKET
61A-11381-A0-00

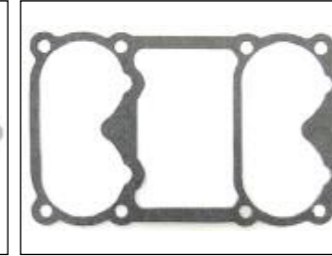

S610485021016
CARB AIR BOX COVER
6E5-14483-A1-00



S610485021017
THERMO COVER GASKET
6H3-12414-A1-00

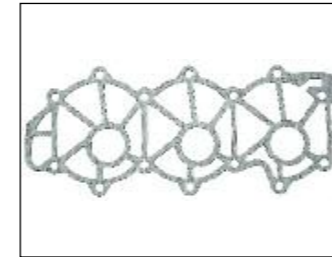

S610485021018
CYLINDER HEAD COVER
6H4-11193-A1-00

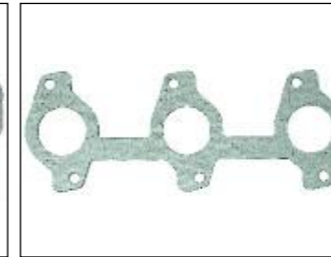

S610485021019
CAB BASE GASKET
6H4-14198-00-00

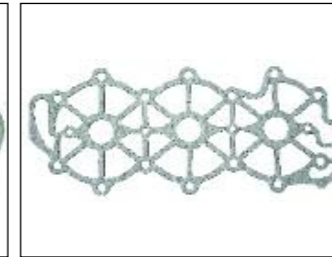

S610485021020
CYLINDER HEAD COVER
630-11193-A0-00



S610485021021
END CAP
6H4-15369-A1-00



S610485021022
RUBBER COVER GASKET
N.A.



S610485021023
RUBBER COVER GASKET
6H4-14198-01

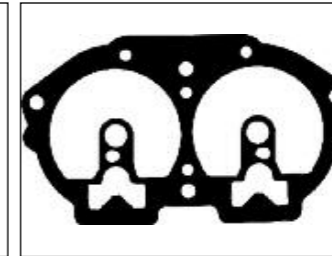

S610485021024
RUBBER GASKET
6H3-14457-01

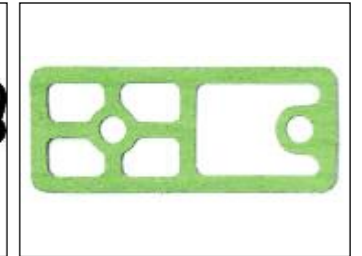

S610485021026
PACKING LOWER CASIN
679-45315-A0



S610485021027
GASKET HEAD COVER
6G1-11193-A1

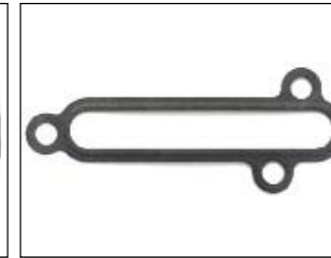

S610485021028
GASKET
62Y-13475-00

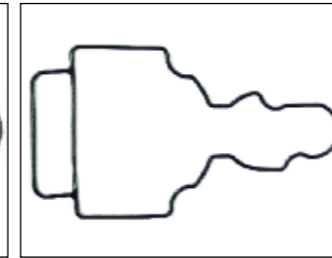

S610485021029
PACKING LOWER CASIN
61N-45315-00



S610485021030
SEAL 2
65W-45128-00

YAMAHA

YAMAHA

CUSTOMER SERVICE - SERVIZIO CLIENTI: info@athena-ad.com

CUSTOMER SERVICE - SERVIZIO CLIENTI: info@athena-ad.com



S610485021031
CSEAL
62Y-45127-00



S610485021032
GASKET
682-12414-A1



S610485021033
GASKET UPPER CASING
682-45113-A1



S610485021035
PACKING LOWER CASING
63V-45315-A0

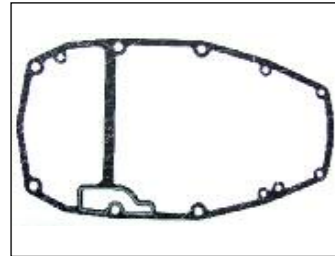

S610485021036
GASKET UPPER CASING
66M-45113-00



S610485021037
SEAL 2
66M-45128-00



S610485021038
SEAL 1
66M-41138-00



S610485021039
GASKET UPPER CASING
66M-45115-00



S610485021040
GASKET COVER
62Y-12414-00

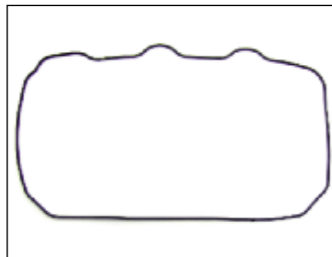

S610485021041
SEAL CYLINDER 2
67C-11356-00

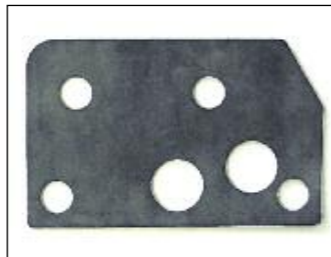

S610485021042
GASKET BREATHER COVER
65W-11169-00

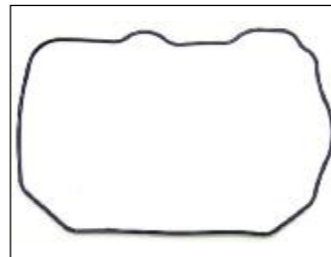

S610485021043
SEAL CYLINDER 2
65W-11356-00



S610485021044
SEAL 2
65W-14457-10

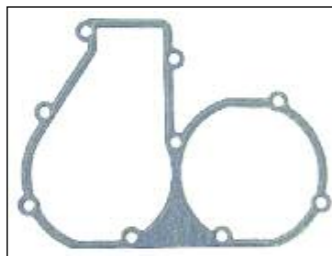

S610485021045
GASKET VALVE SEAT
648-13621-A1



S610485021046
GASKET MANIFOLD
648-13645-A0



S610485021047
GASKET COVER
655-12414-A1



S610485021050
GASKET UPPER CASING
63D-45114-A0



S610485021051
SEAL
6H3-45127-00



S610485021052
GASKET MANIFOLD 1
66M-13645-00

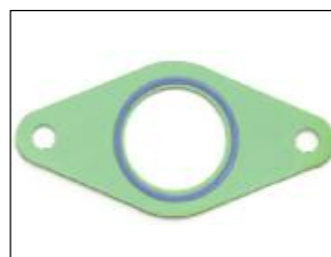

S610485021053
GASKET MANIFOLD 2
66M-13646-00

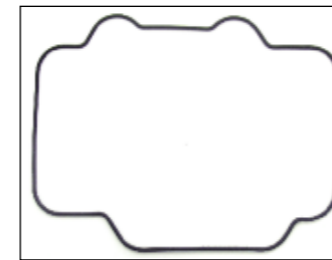

S610485021054
SEAL CYLINDER 2
66M-11356-00

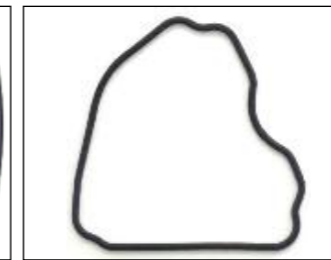

S610485021055
SEAL CYLINDER 3
66M-11357-00

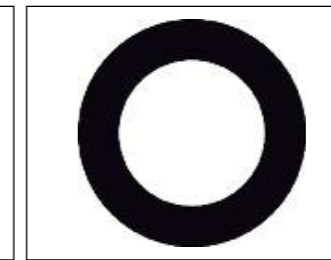

S610485021057
RUBBER GASKET
90430-12072

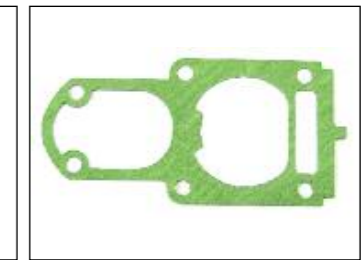

S610485021058
PACKING LOWER CASING
6L2-45315-A0

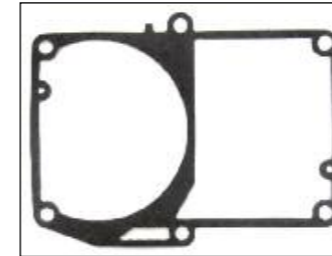

S610485021059
GASKET UPPER CASING
6L2-45113-A2



S610485021060
GASKET
6L2-14198-00

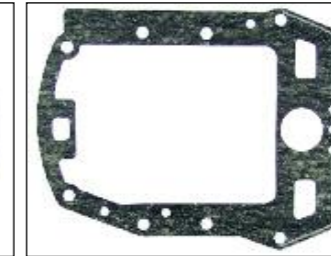

S610485021061
GASKET UPPER CASING
676-45114-A1

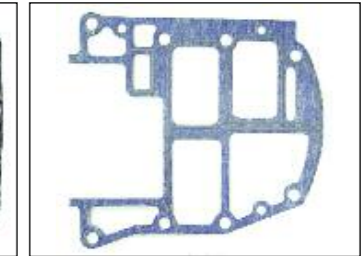

S610485021062
GASKET UPPER CASING
6F5-45113-A0



S610485021063
PACKING LOWER CASING
6G1-45315-A0

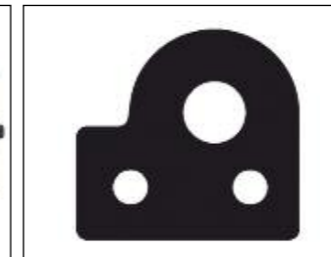

S610485021066
GASKET MUFFLER
67C-45123-00



S610485024002
COVER GASKET
6E5-11193-A0-00

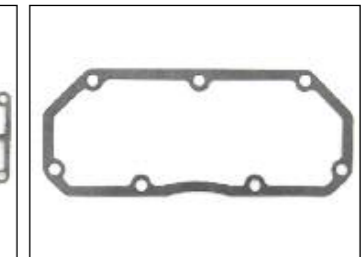

S610485024003
COVER GASKET
6E5-11381-A1-00



S610485024004
GASKET WATER PUMP
68F-11381-00



S610485024005
GASKET CARTRIDGE
676-44324-A0

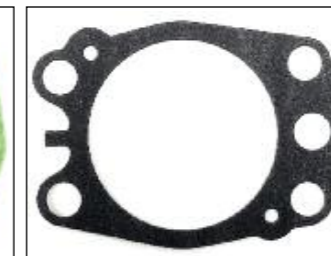

S610485024006
GASKET WATER PUMP
676-44315-A1



S610485024007
GASKET WATER PUMP
679-44316-A0



S610485024008
DAMPTER WATER SEAL
6L2-44367-00

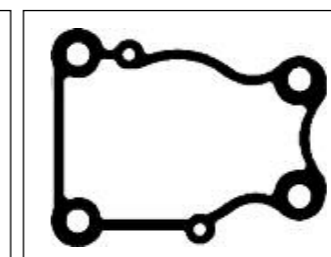

S610485024009
GASKET WATER PUMP
63D-44316-00

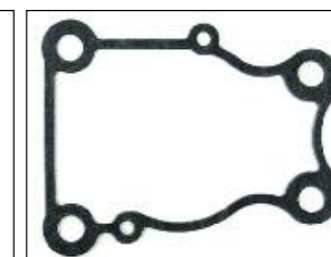

S610485024014
GASKET WATER PUMP
63D-44316-00



S610485024015
GASKET PUMPCOVER
66M-13329-10

YAMAHA

YAMAHA

CUSTOMER SERVICE - SERVIZIO CLIENTI: info@athena-ad.com

CUSTOMER SERVICE - SERVIZIO CLIENTI: info@athena-ad.com



S610485024017
GASKET WATER PUMP
6E9-12414-A1



S610485024018
GASKET WATER PUMP
6G1-44315-A0



S610485026001
GASKET OIL PAN
62Y-15312-00



S610485026002
GASKET UPPER CASING
67C-45113-00

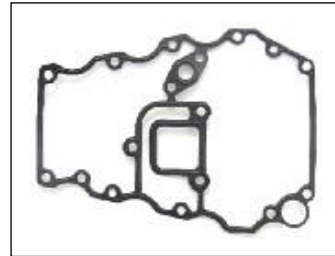

S610485026003
GASKET OIL PAN
67C-15312-00

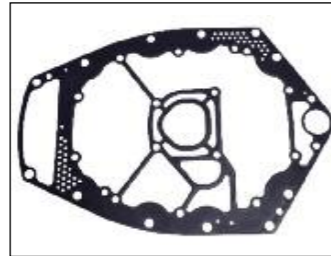

S610485026006
GASKET OIL PAN
63P-15312-00

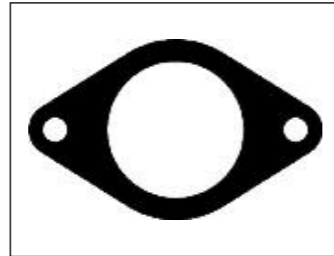

S610485108003
CARB MOUNT GASKET
N.A.

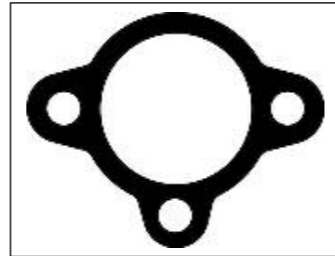

S610485150001
THERMOSTAT GASKET
6G8-12414-A0

APPLICATIONS APPLICAZIONI	CYLINDER CILINDRI	GASKET KIT KIT GUARNIZIONI MOTORE	HEAD GASKET GUARNIZIONE TESTA CILINDRO	NOTE
110/165 HP (2.5-3.0 L)	4	P700337999004	-	
153 (2.5/3.0 L)	4	-	S710337001003	
175/185/205 HP	V-6	P700337999005	-	
181 HP (3.0 L)	4	P700337850003	-	
181 HP (3.0 L)	4	P700337999002	S710337001002	
181 HP (3.0 L)	4	P700337999006	-	
262 (4.3L)	V-6	P700337850001	S710337001001	
262 (4.3L)	V-6	P700337999007	S710337001001 S710337001005	
300/305 HP (5.0/5.7 L)	V-8	-	S710337001004	
INTERNAL ENGINES		P700337999009	-	
INTERNAL ENGINES		P700337999010	-	

GASKET KIT
KIT GUARNIZIONI

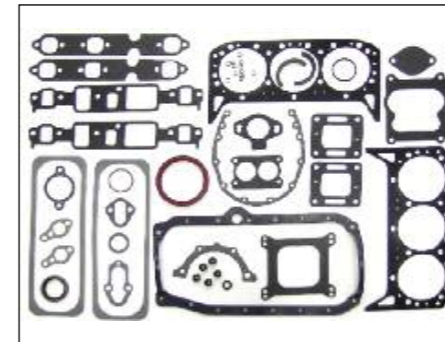

P700337850001
27-34213A2

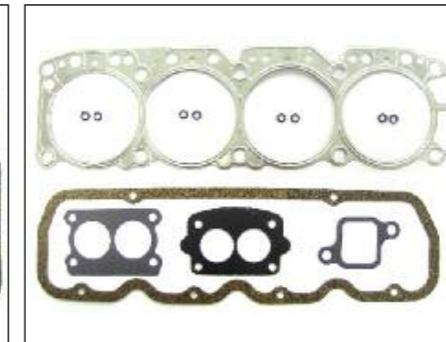

P700337999002
27-34213A2

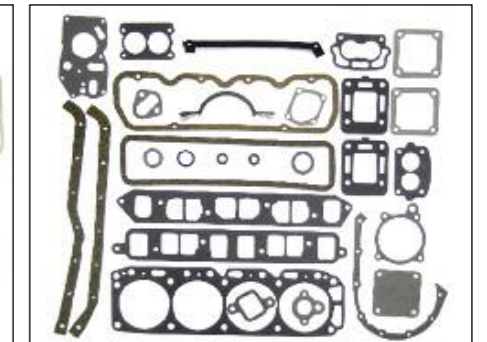

P700337850003
N.A.



P700337999004
N.A.



P700337999005
N.A.



P700337999006
27-11977A88



P700337999007
N.A.

P700337999009
27-94996Q2

P700337999010
27-35996A1

**HEAD GASKET
GUARNIZIONI TESTA CILINDRO**



S710337001001
N.A.

S710337001002
27-52364

S710337001003
27-34273

S710337001004
27-75611



S710337001005
27-11986

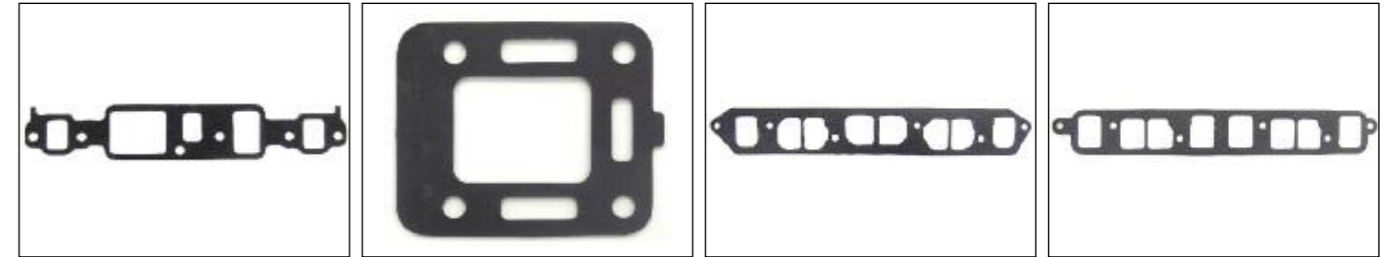

S710337010001
INTAKE GASKET
24-11977

S710337012002
EXHAUST ELBOW GASKET
27-99777-2

S710337012003
EXHAUST ELBOW GASKET
27-96429

S710337012004
EXHAUST ELBOW GASKET
27-53354



S710337012006
EXHAUST ELBOW GASKET
27-52546

S710337012007
INLET ELBOW GASKET
27-824236

S710337015001
OIL PAN GASKET
27-13865-1

S710337015002
VALVE COVER GASKET
27-49936



S710337021001
CARBURETOR GASKET
27-41610

S710337021002
CARBURETOR GASKET
27-52457-2

S710337021003
CARBURETOR GASKET
27-70143-1

S710337021004
REAR SEAL GASKET
27-142147



S710337021005
CIRCLE GASKET
N.A.

S710337021006
CIRCLE GASKET
N.A.

S710337021009
CARBURETOR GASKET
27-64692

S710337021010
CARBURETOR GASKET
N.A.

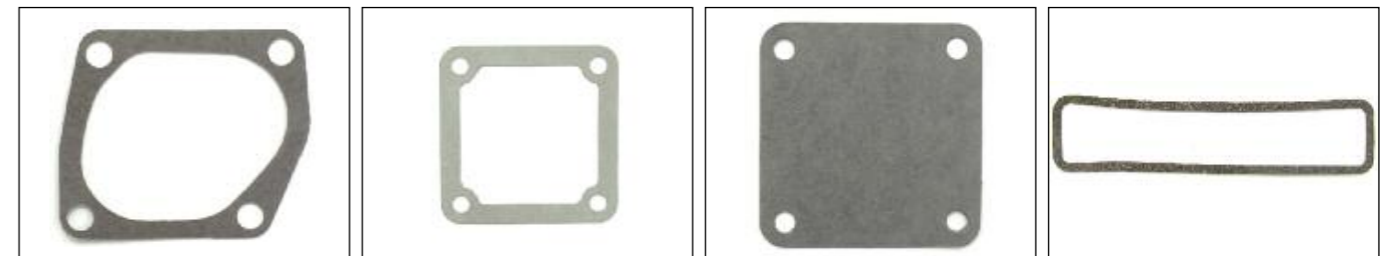

S710337021011
CARBURETOR GASKET
N.A.

S710337021013
MANIFOLD GASKET
27-48043-1

S710337021014
MANIFOLD GASKET
27-73814

S710337021015
PUSH ROD COVER GASKET
27-34208

MERCURISER

MERCURISER

CUSTOMER SERVICE - SERVIZIO CLIENTI: info@athena-ad.com

CUSTOMER SERVICE - SERVIZIO CLIENTI: info@athena-ad.com



S710337021016
PUSH ROD COVER GASKET
27-34209



S710337024001
WATER PUMP GASKET
27-34897



S710337024002
WATER PUMP GASKET
27-49110



S710337024003
WATER PUMP GASKET
N.A.



S710337024004
WATER PUMP GASKET
27-33956

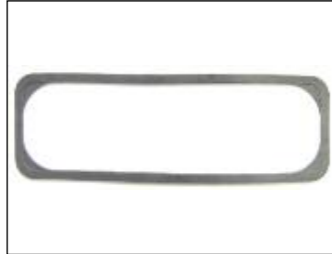

S710337026001
OIL PAN GASKET (2 pieces)
27-883964



S710337026002
OIL PAN GASKET
N.A.



S710337026003
OIL PAN GASKET
N.A.



S710337026004
OIL PAN GASKET
N.A.



S710337026005
OIL PAN GASKET
N.A.



S710337049001
DISTRIBUTOR GASKET
N.A.



S710337049002
DISTRIBUTOR GASKET
27-34486-3



S710337049003
DISTRIBUTOR GASKET
27-87707

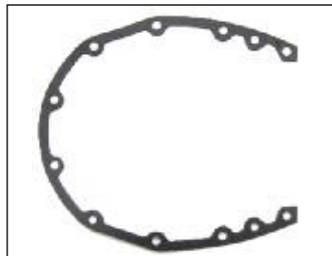

S710337078001
TIMING COVER GASKET
27-14250



S710337078002
TIMING COVER GASKET
27-49953



S710337078003
TIMING COVER GASKET
27-81572



S710337078004
TIMING COVER GASKET
N.A.



S710337078005
TIMING COVER GASKET
N.A.



S710337086001
FUEL PUMP GASKET
27-34213



S710337150001
THERMOSTAT GASKET
27-41812



S710337150002
THERMOSTAT GASKET
N.A.



S710337150003
THERMOSTAT GASKET
27-33179-2



S710337150004
THERMOSTAT GASKET
27-53045-1

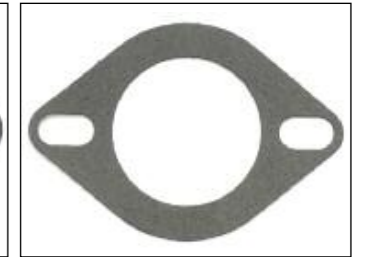

S710337150005
THERMOSTAT GASKET
N.A.



S710337150006
THERMOSTAT GASKET
27-47590-1

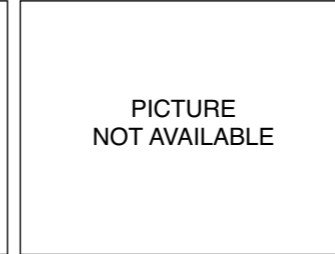

S710337150007
THERMOSTAT GASKET
N.A.

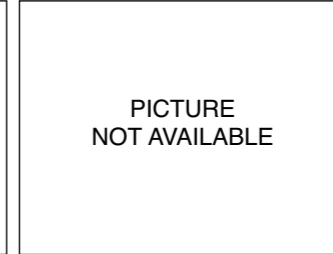

S710337015003
OUTDRIVE HOUSING
27-949962

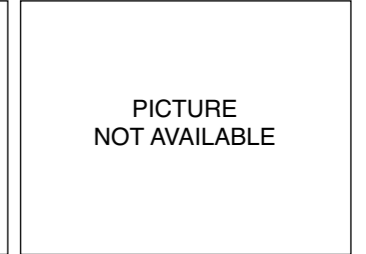

S710337015004
OUTDRIVE HOUSING
27-35996

APPLICATIONS APPLICAZIONI	CYLINDER CILINDRI	HEAD GASKET GUARNIZIONE TESTA CILINDRO	NOTE
ENGINE MD5A, MD5B, MD5C	1	S710530001001	
153 (2.5/3.0 L)	4	S710337001003	
181 HP (3.0 L)	4	S710337001002	
262 (4.3L)	V-6	S710337001005	
300/305 HP (5.0/5.7 L)	V-8	S710337001004	

**HEAD GASKET
GUARNIZIONI TESTA CILINDRO**



S710530001001
859134



S710337001002
3853336, 908611
913274, 914812

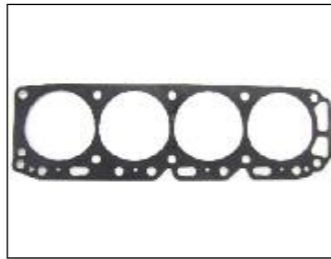

S710337001003
311210

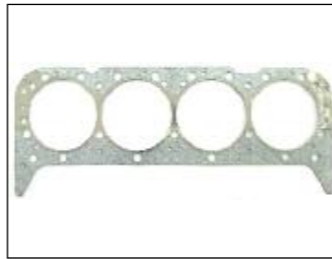

S710337001004
841207-4, 856474-2

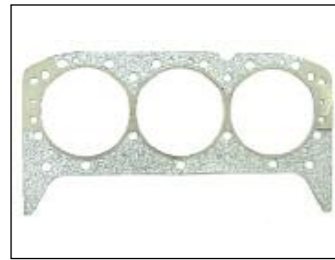

S710337001005
3854299, 912227
914930,910833

**INDIVIDUAL GASKET
GUARNIZIONI SFUSE**

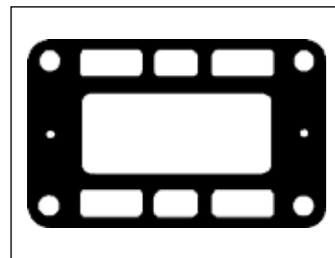

S710530010001
INTAKE GASKET
835909



S710530012001
EXHAUSTGASKET
N.A.

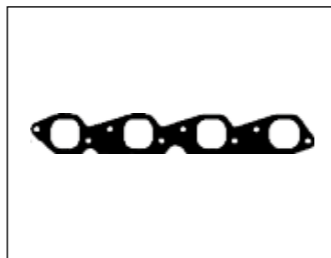

S710530012002
EXHAUSTGASKET
N.A.

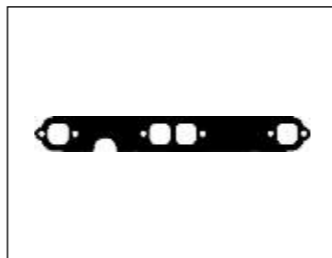

S710530012003
EXHAUSTGASKET
N.A.

APPLICATIONS APPLICAZIONI	CYLINDER CILINDRI	GASKET KIT KIT GUARNIZIONINI MOTORE	HEAD GASKET GUARNIZIONE TESTA CILINDRO	NOTE
7 HP - 1GM	1	P700600850001	S710600001001	
9 HP - 1GM10	1	P700600850002	S710600001002	
18 HP - 2GM20	2	P700600850003	S710600001003	
18 HP - 2GM20F	2	P700600850003	S710600001003	
27 HP - 3GM30	3	P700600850004	S710600001004	
27 HP - 3GM30 (EU)	3	P700600850004	S710600001004	
27 HP - 3GM30F	3	P700600850004	S710600001004	
27 HP - 3GM30F(EU)	3	P700600850004	S710600001004	
38 HP - 3JH2E	3	P700600850005	S710600001005	
55 HP - 3JH2TE	3	P700600850005	S710600001005	
40 HP - 3JH3EYEU	3	P700600850006	S710600001006	
44 HP - 4JHE	4	P700600850007	S710600001007	
55 HP - 4JHTE	4	P700600850007	S710600001007	
77 HP - 4JHDTE	4	P700600850007	S710600001007	
62 HP - 4JH2E	4	P700600850008	S710600001008	
72 HP - 4JH2TE	4	P700600850008	S710600001008	
83 HP - 4JH2HTE	4	P700600850008	S710600001008	
95 HP - 4JH2DTE	4	P700600850008	S710600001008	
106 HP - 4JH2UTE	4	P700600850008	S710600001008	
125 HP - 4LHTE	4	P700600850009	S710600001009	
142 HP - 4LHTE	4	P700600850009	S710600001009	
182 HP - 4LHTE	4	P700600850009	S710600001009	
238 HP - 4LHTE	4	P700600850009	S710600001009	
150 HP - 4LHAHTE	4	P700600850010	S710600001009	
190 HP - 4LHADTE	4	P700600850010	S710600001009	
238 HP - 4LHASTE	4	P700600850010	S710600001009	



P700600850001



P700600850002



P700600850003



P700600850004

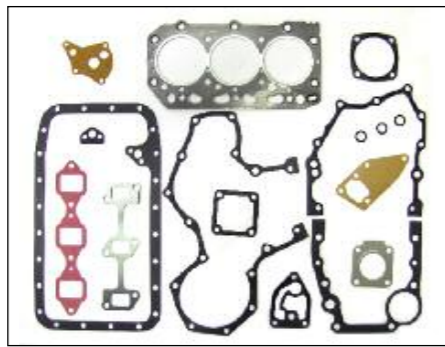

P700600850005

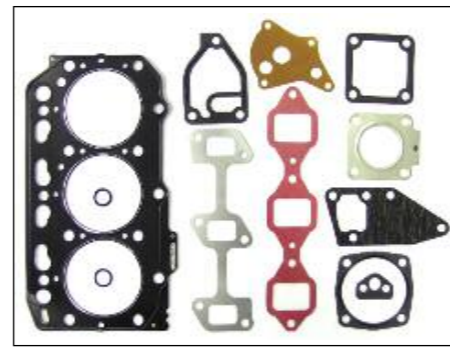

P700600850006

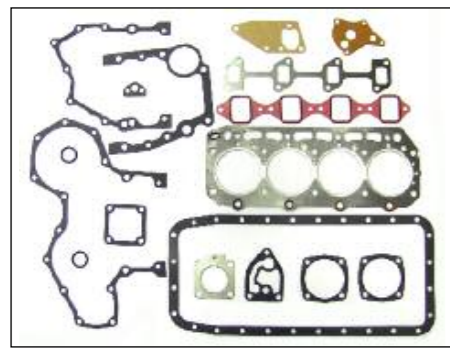

P700600850007

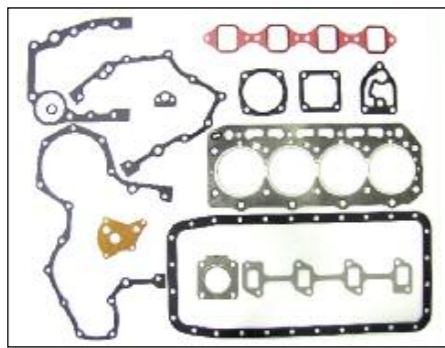

P700600850008



P700600850009

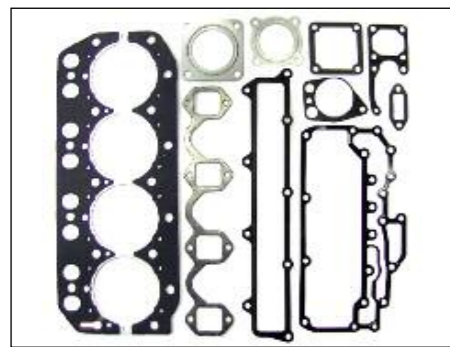

P700600850010



S710600001001
128170-01331



S710600001002
128171-01911



S710600001003
128271-01911



S710600001004
128374-01911



S710600001005
129171-01330



S710600001006
129002-01331



S710600001007
129553-01350



S710600001008
129573-01351



S710600001009
119174-01340

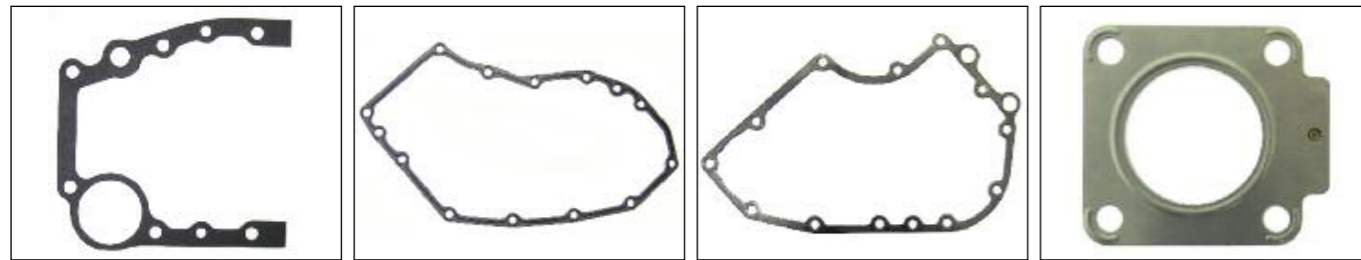

S71060006001
BASE GASKET
N.A.

S71060007001
HOUSING MOTOR GASKET
128170-01510

S71060007002
HOUSING MOTOR GASKET
121575-01510

S710600012001
EXHAUST GASKET
N.A.



S710600021001
COVER GASKET
128170-11310

S710600021002
COVER GASKET
128170-03070

S710600021003
COVER GASKET
128170-42090

S710600021004
COVER GASKET
104211-49160



S710600021005
COVER GASKET
128270-11310

S710600021006
COVER GASKET
N.A.

S710600021007
COVER GASKET
N.A.

S710600021008
COVER GASKET
N.A.

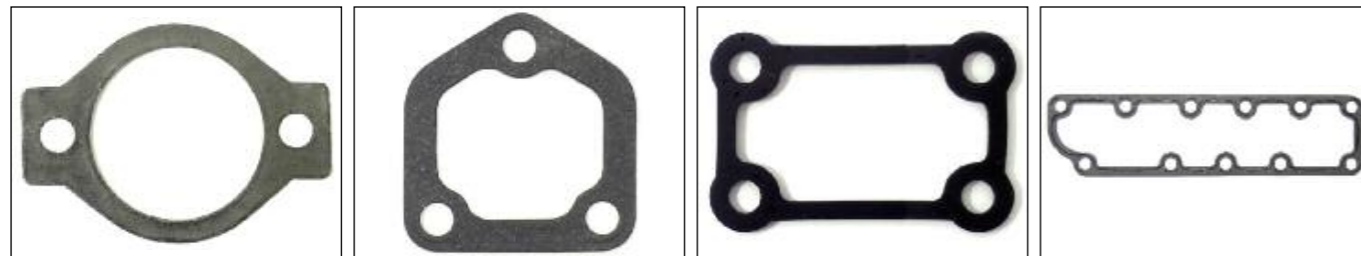

S710600021009
COVER GASKET
N.A.

S710600021010
COVER GASKET
N.A.

S710600021011
COVER GASKET
N.A.

S710600021012
COVER GASKET
128370-13181



S710600021013
COVER GASKET
N.A.

S710600021014
COVER GASKET
N.A.

S710600021015
COVER GASKET
N.A.

S710600021016
COVER GASKET
N.A.



S710600021017
COVER GASKET
N.A.

S710600021018
COVER GASKET
N.A.

S710600021019
COVER GASKET
N.A.

S710600021020
COVER GASKET
N.A.



S710600021021
COVER GASKET
N.A.

S710600021022
COVER GASKET
N.A.

S710600021023
COVER GASKET
N.A.

S710600021024
COVER GASKET
N.A.

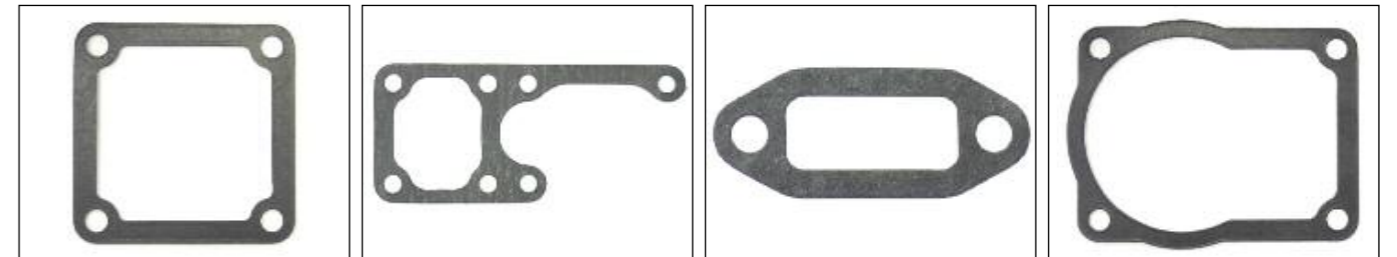

S710600021025
COVER GASKET
N.A.

S710600021026
COVER GASKET
N.A.

S710600021027
COVER GASKET
N.A.

S710600021028
COVER GASKET
N.A.



S710600021029
COVER GASKET
N.A.

S710600021030
COVER GASKET
N.A.

S710600021031
COVER GASKET
N.A.

S710600021032
COVER GASKET
N.A.



S710600021033
COVER GASKET
N.A.

S710600021034
COVER GASKET
N.A.

S710600021035
COVER GASKET
N.A.

S710600021036
COVER GASKET
N.A.

YANMAR

YANMAR

CUSTOMER SERVICE - SERVIZIO CLIENTI: info@athena-ad.com

CUSTOMER SERVICE - SERVIZIO CLIENTI: info@athena-ad.com



S710600024001
WATER PUMP GASKET
128170-32030



S710600024002
WATER PUMP GASKET
124223-42110

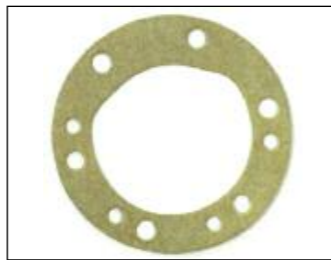

S710600024003
WATER PUMP GASKET
N.A.



S710600024004
WATER PUMP GASKET
N.A.



S710600024005
WATER PUMP GASKET
N.A.

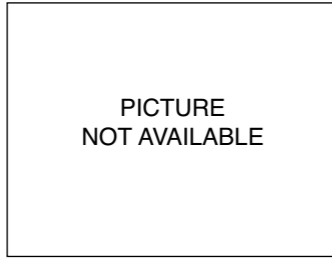

S710600024006
WATER PUMP GASKET
N.A.

PICTURE
NOT AVAILABLE

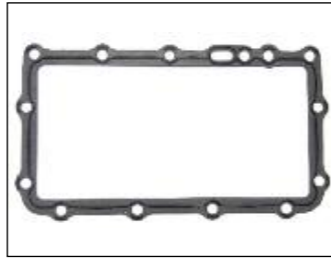

S710600026001
OIL PAN GASKET
128170-01750



S710600026002
OIL PAN GASKET
124000-01751

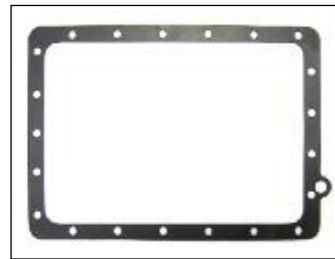

S710600026003
OIL PAN GASKET
121000-01751



S710600026004
OIL PAN GASKET
129198-01750

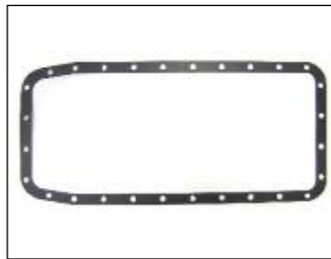

S710600026005
OIL PAN GASKET
129400-01750



S710600086001
FEED PUMP GASKET
121400-01850



S710600108001
FLANGE GASKET
124160-34845



S710600150001
THERMOSTAT GASKET
N.A.



S710600154001
BONDED SEAL
43400-500390



S710600154002
BONDED SEAL
43400-500450



S710600154003
BONDED SEAL
43400-500570

APPLICATIONS APPLICAZIONI	YEAR ANNO	FULL GASKET KIT KIT G.NI MOTORE	TOP-END GASKET KIT KIT G.NI SMERIGLIO	ENGINE OIL SEAL KIT KIT PARAOLIO	HEAD GASKET GUARNIZIONI TESTA	BASE GASKET GUARNIZIONI BASE
300 SX	86-91	P600250850300	P600250600300	NA	S610250001007	S610250006004
440 SX	77-80	P600250850400	P600250600400	NA	S610250001006	S610250006001
550 SX	81-92	P600250850401	P600250600401	NA	S610250001005	S610250006001
	82-85	P600250850500	P600250600500	NA	S610250001001	S610250006001
	86-90	P600250850501	P600250600500	NA	S610250001001	S610250006001
650	91-94	P600250850502	P600250600502	NA	S610250001009	S610250006003
	89-93	P600250850600	P600250600600	NA	S610250001004	S610250006002
750 SS	92-93	N/P	P600250600700	NA	S610250001003	S610250006002+
750 SS	94-97					
750 SSSI	93-97	P600250850001	P600250600001	P600250400001	S610250001014	S610250006002
750 STS	94-95					
750 STS	95	P600250850002	P600250600001	P600250400001	S610250001014	S610250006002
750 SX	92-95	P600250850700	NA	P600250400001	S610250001014	S610250006002
750 SXI	95-96					
750 SXI PRO	98-02	P600250850007	P600250600007	P600250400001	S610250001014	S610250006002
750 XIR	94	P600250850008	P600250600008	P600250400001	S610250001014	S610250006002
750 XI SPORT	98-99	P600250850001	P600250600001	P600250400001	S610250001014	S610250006002
750 ZXI	95-97	P600250850702	NA	P600250400001	S610250001014	S610250006002
800 SX-R	03-06	P600250850003	NA	P600250400001	S610250001015	S610250006002
900 ZXI	95-97					
900 STX	97-06	P600250850900	P600250600900	P600250400900	S610250001010	S610250006005
900 STS	01-02					
1100 STX	97-99					
1100 STX DI	00-03					
1100 Ultra 130 DI	01-04	P600250850004	P600250600004	P600250400004	S610250001013	S610250006008
1100 Zxi	96-03					
1200 STX-R	02-05					
1200 ULTRA 150	00-05	P600250850005	P600250600005	NA	S610250001012	S610250006007
1200 STX-F (12F)	03-07					
1500 STX-F (15F)	04-08	P600250850006	NA	NA	S610250001020	S610250006009
ULTRA 250X	07-08					
ULTRA 260 LX	09-10	NA	P600250600260	NA	S610250001019	S610250006009
ULTRA 260 X	09-10					



P60025040001 NEW



P60025040004 NEW



P60025040090



P60025060001 NEW



P60025060004 NEW



P60025060005 NEW

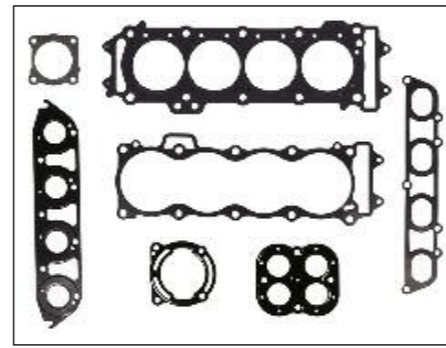

P60025060026



P60025060030

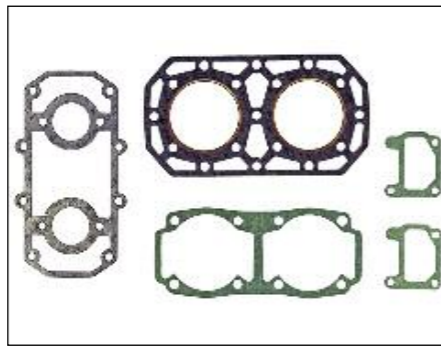

P60025060040

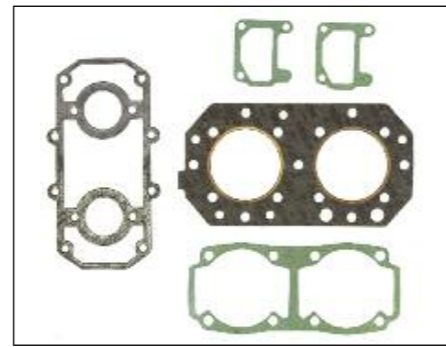

P60025060041

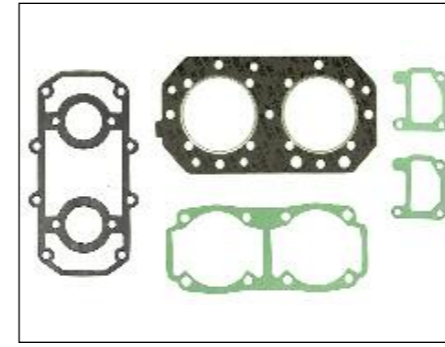

P60025060050

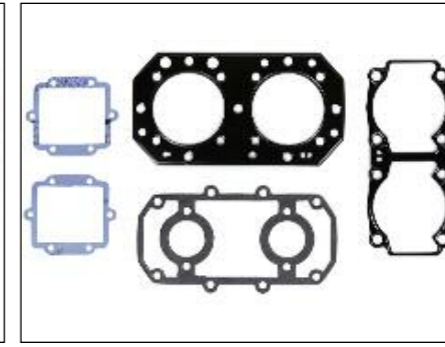

P60025060052

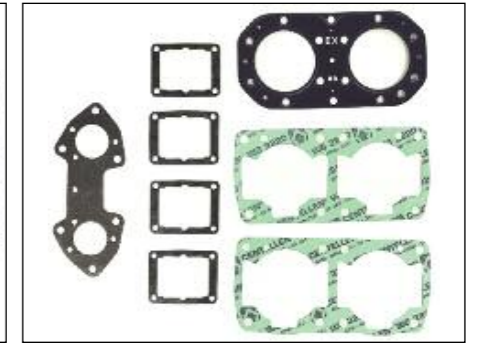

P60025060060

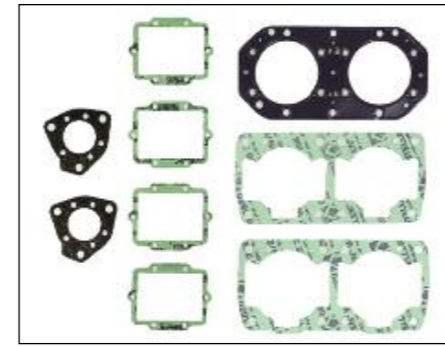

P60025060070

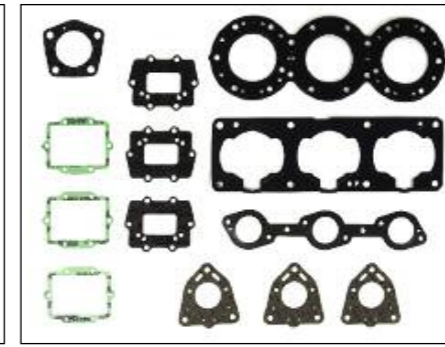

P60025060090



P600250850001 NEW



P600250850002 NEW



P600250850003 NEW



P600250850004 NEW



P600250850005 NEW

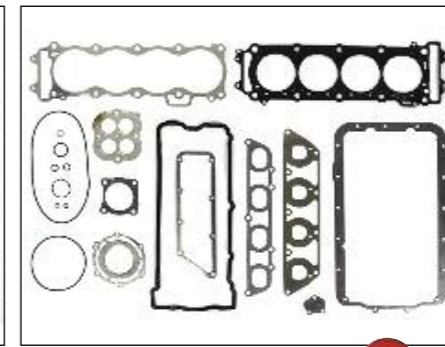

P600250850006 NEW



P600250850300

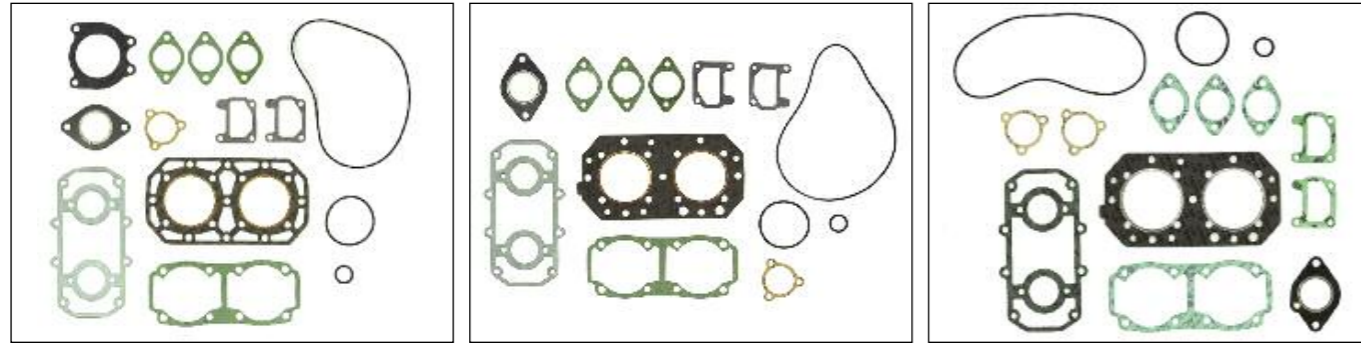

P600250850400

P600250850401

P600250850500

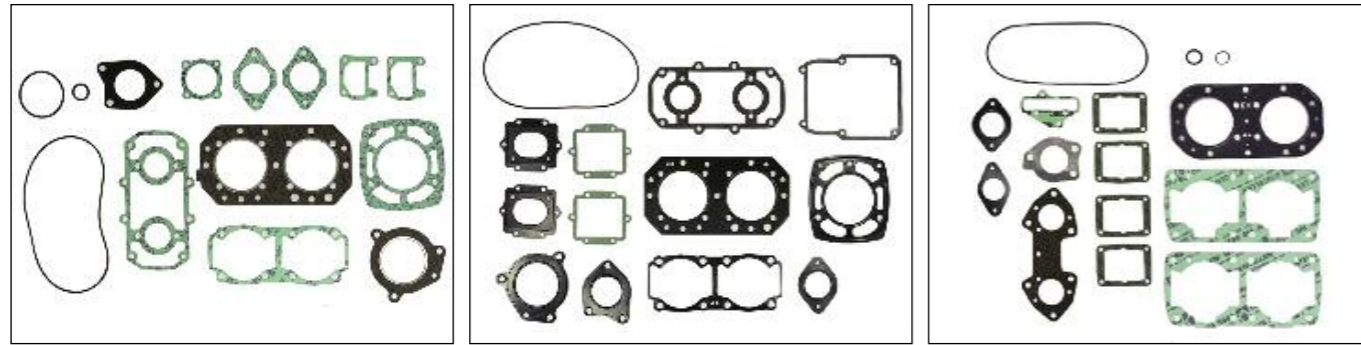

P600250850501

P600250850502

P600250850600

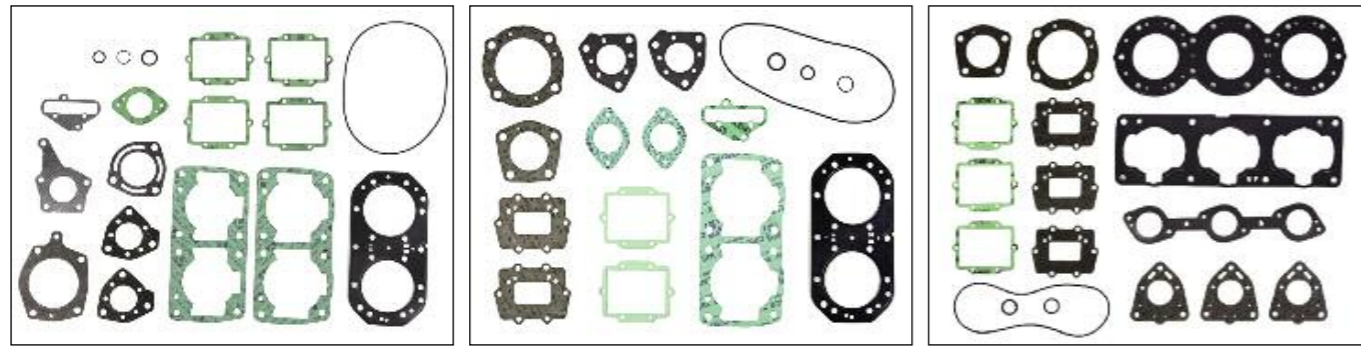

P600250850700

P600250850702

P600250850900

HEAD GASKET
GUARNIZIONI TESTA

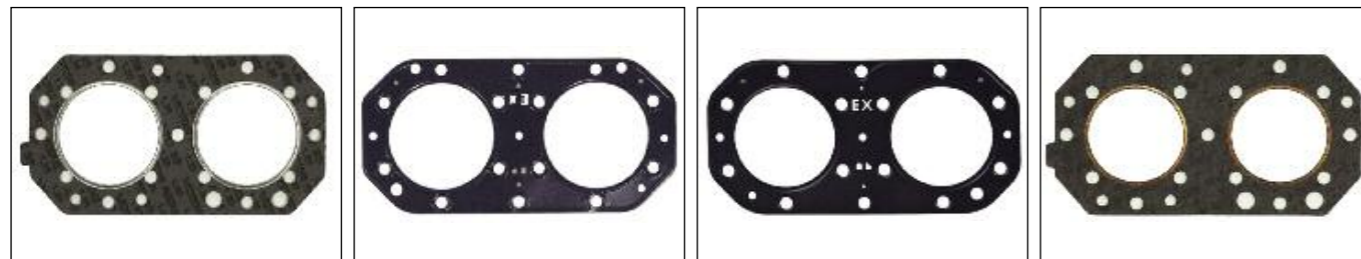

S610250001001
11004-3709

S610250001003
11004-3708

S610250001004
11004-3716

S610250001005
11004-3019

HEAD GASKET
GUARNIZIONI TESTA

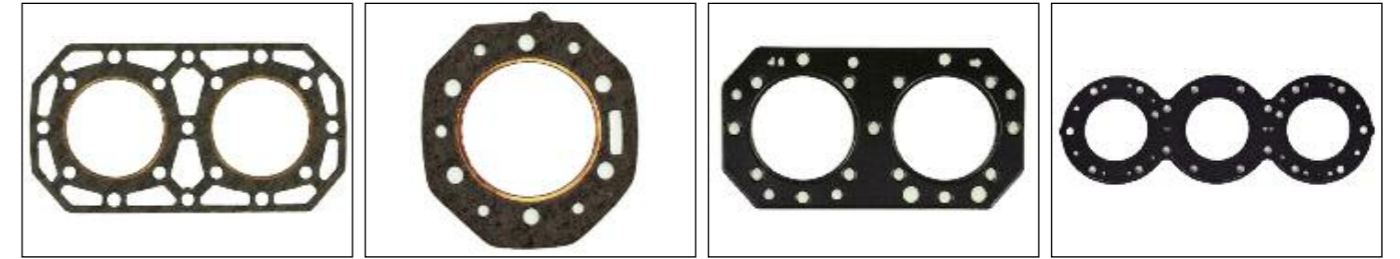

S610250001006
11004-3008

S610250001007
11004-3703

S610250001009
11004-3706

S610250001010
11004-3713



S610250001012 (x3) **NEW**
11004-3717

S610250001013 **NEW**
11004-3715

S610250001014 **NEW**
11004-3714

S610250001015 **NEW**
11004-3720



S610250001019
11004-3722

S610250001020 **NEW**
11004-3721

BASE GASKET
GUARNIZIONI BASE

S610250006001
11009-3782



S610250006002 **NEW**
11009-3711

S610250006003
11009-3780

S610250006004
11009-3706

S610250006005
11009-3752



S610250006007 (x3)
11060-3783

S610250006008 **NEW**
11060-3760

S610250006009 **NEW**
11061-3708

KAWASAKI JET SKI

KAWASAKI JET SKI

CUSTOMER SERVICE - SERVIZIO CLIENTI: info@athena-ad.com

CUSTOMER SERVICE - SERVIZIO CLIENTI: info@athena-ad.com



S610250010001
INTAKE GASKET
16062-510

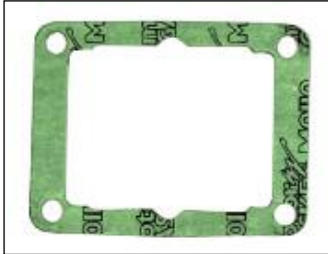

S610250010002
INTAKE GASKET
11060-3703

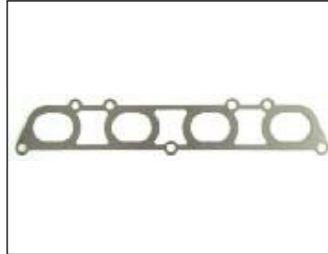

S610250010007
INTAKE MANIFOLD GASKET
11060-3716



S610250010008
INTAKE GASKET
11061-3738



S610250010010
INTAKE COVER GASKET
11061-3737



S610250012001
EXHAUST GASKET
-



S610250012003
EXHAUST GASKET
11060-3759



S610250012004
EXHAUST GASKET
11060-3721



S610250012005
EXHAUST GASKET
11060-3730



S610250012006
UPPER EXHAUST GASKET
11060-3728



S610250012007
EXHAUST GASKET
11060-3726



S610250012008
COVER EXHAUST GASKET
11060-3727



S610250012009
LOWER EXHAUST GASKET
11009-3777



S610250012010
UPPER EXHAUST GASKET
11009-2446



S610250012011
EXHAUST GASKET
11009-3778



S610250012012
EXHAUST MANIFOLD GASKET
11009-3788



S610250012013
EXHAUST MANIFOLD GASKET
11009-3722



S610250012014
EXHAUST GASKET
11009-3723

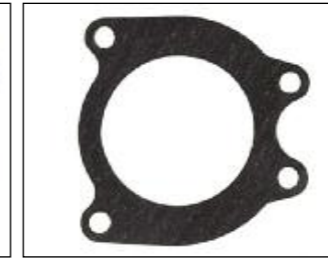

S610250012015
EXHAUST GASKET
92065-515

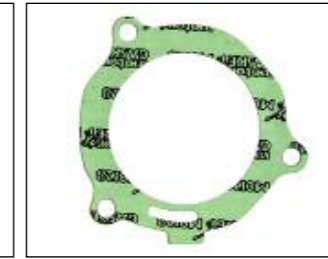

S610250012016
EXHAUST MANIFOLD GASKET
11009-3708



S610250012017
EXHAUST MANIFOLD GASKET
11009-3750

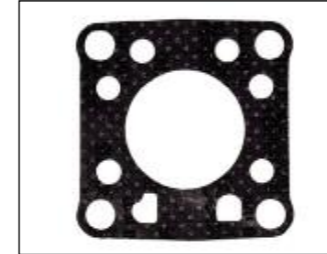

S610250012018
EXHAUST GASKET
11009-3744



S610250012020
EXHAUST GASKET
11060-3756



S610250012021
EXHAUST GASKET
11060-3754



S610250012022
EXHAUST GASKET
11060-3757



S610250012023
EXHAUST GASKET
11060-3769



S610250012024
EXHAUST GASKET
11060-3732



S610250012025
EXHAUST GASKET
-



S610250012026
EXHAUST GASKET
11060-3718



S610250012027
EXHAUST GASKET
11060-3766

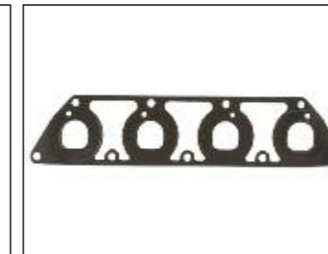

S610250012028
EXHAUST MANIFOLD GASKET
11061-3713



S610250012029
EXHAUST GASKET
11061-3714



S610250012036
EXHAUST GASKET
11060-3785



S610250012037
EXHAUST GASKET
11060-3786



S610250012043
EXHAUST GASKET
11060-3768



S610250012047
EXHAUST GASKET
11061-3760



S610250012048
EXHAUST GASKET
11061-3762

KAWASAKI JET SKI

KAWASAKI JET SKI

CUSTOMER SERVICE - SERVIZIO CLIENTI: info@athena-ad.com

CUSTOMER SERVICE - SERVIZIO CLIENTI: info@athena-ad.com

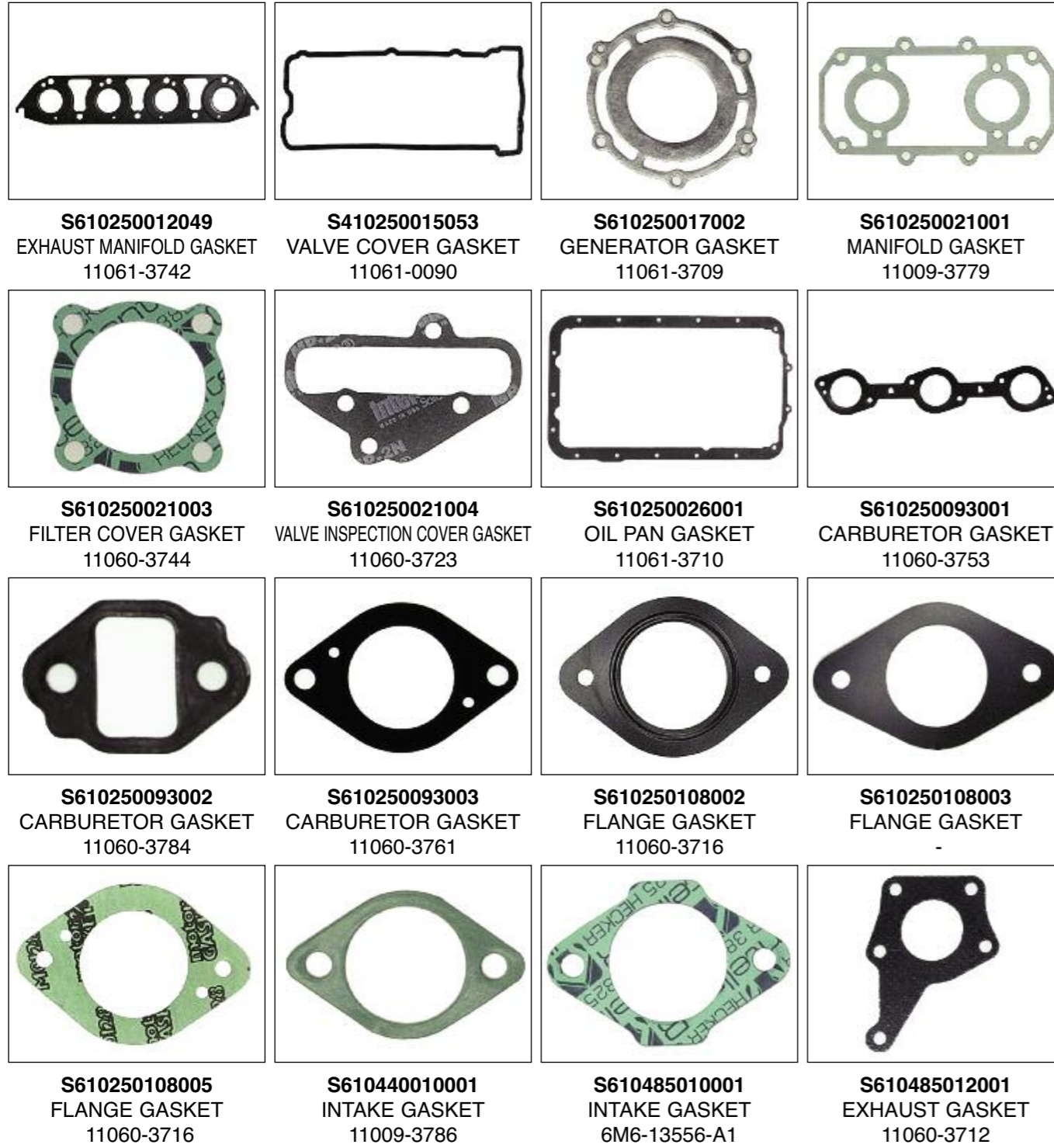

APPLICATIONS APPLICAZIONI	YEAR ANNO	FULL GASKET KIT KIT G.NI MOTORE	TOP-END GASKET KIT KIT G.NI SMERIGLIO	ENGINE OIL SEAL KIT KIT PARAOLIO	HEAD GASKET GUARNIZIONI TESTA	BASE GASKET GUARNIZIONI BASE
650	ALL	P600427850004	P600427600004	-	S610427001001	S610427006002
700	ALL	P600427850001	NA	-	OR M751802350094 INT OR M751802500004 EXT	S610427006001
700 FREEDOM	03-06					
750	ALL	P600427850005	P600427600005	-	S610427001002	S610427006002
780	ALL	P600427850006	P600427600006	-	S610427001003	S610427006002
800 (777)	ALL	P600427850007	NA	-	OR M751802350094 INT OR M751802500004 EXT	S610427006004
900	ALL	P600427850002	NA	-	OR M751802325094 INT OR M751802500004 EXT	S610427006001
1050	ALL	P600427850003	NA	-	OR M751802350094 INT OR M751802500004 EXT	S610427006001
1200 w/early style cases	ut to 00	P600427850009	P600427600009	-	OR M751802350094 INT	S610427006004
1200 w/late style cases w/carbs	01 & up			-	OR M751802500004 EXT	
1200 fuel injected	03	P600427850008	P600427600009	-		

GASKET KIT
KIT GUARNIZIONI

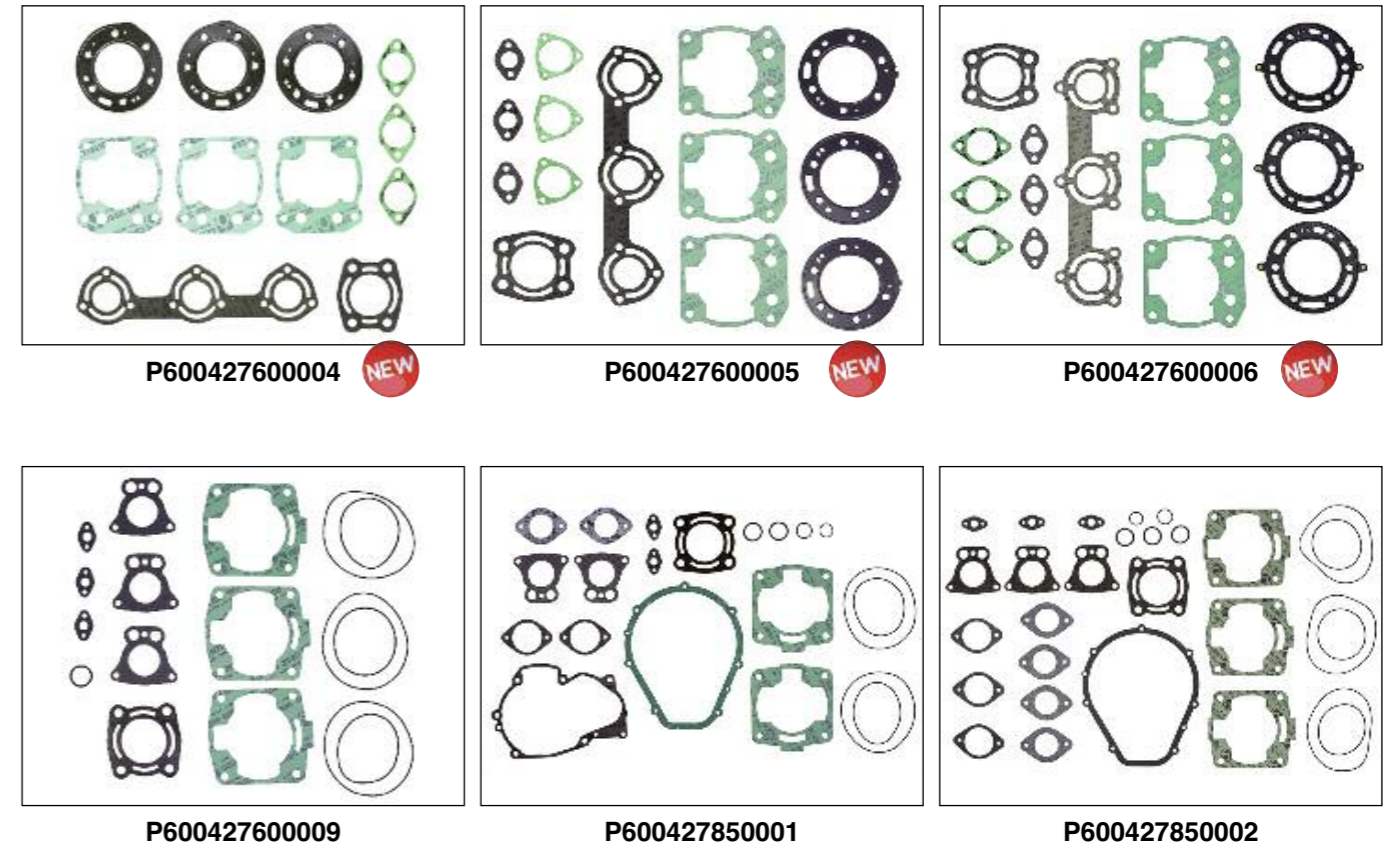

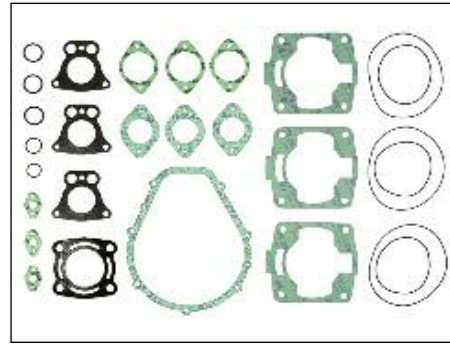

P600427850003

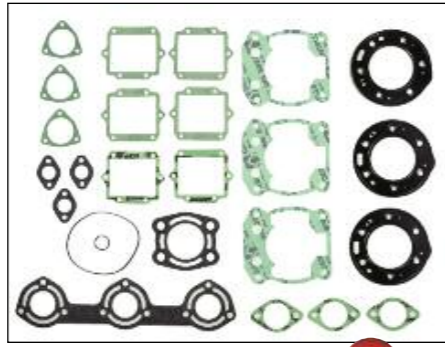

P600427850004 **NEW**

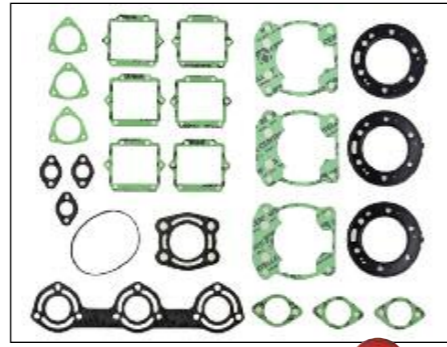

P600427850005 **NEW**

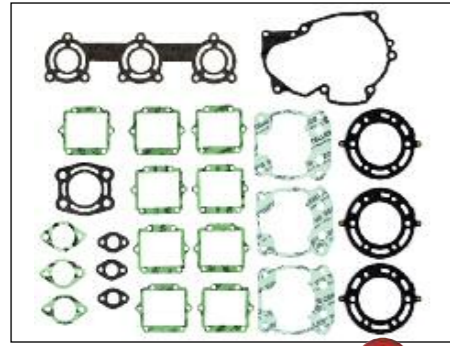

P600427850006 **NEW**



P600427850007 **NEW**

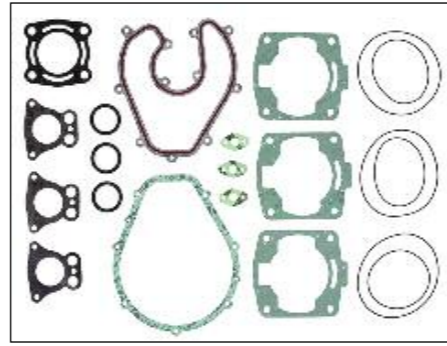

P600427850008

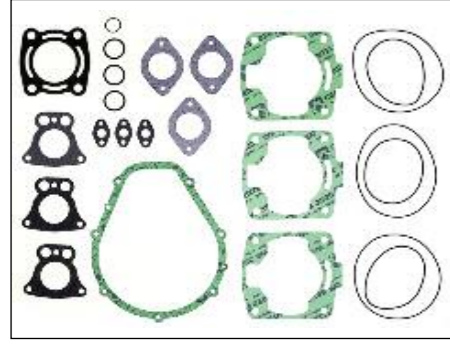

P600427850009

HEAD GASKET
GUARNIZIONI TESTA



S610427001001 (3)
3240191



S610427001002 (3)
3240213



S610427001003 (3)
3240251



S610427006001
5811057



S610427006002 (3)
3240055



S610427006004
5811784

INDIVIDUAL GASKET
GUARNIZIONI SFUSE



S510427108001
3082937



S610427010001
INTAKE GASKET



S610427012001
EXHAUST GASKET
5830051



S610427012002
EXHAUST GASKET
5811045

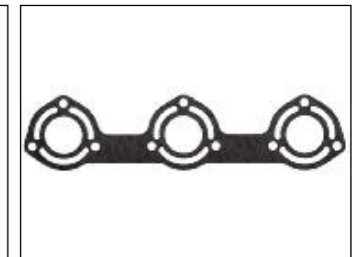

S610427012003
EXHAUST MANIFOLD GASKET
5811489



S610427012004
EXHAUST GASKET
5830038

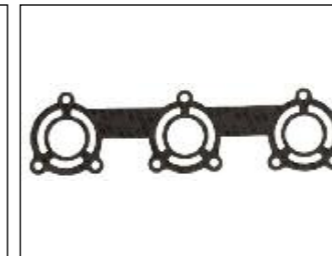

S610427012005
EXHAUST MANIFOLD GASKET
5211623



S610427021001
FLYWHEEL COVER GASKET
5811145



S610427021002
SIDE COVER GASKET
3240045

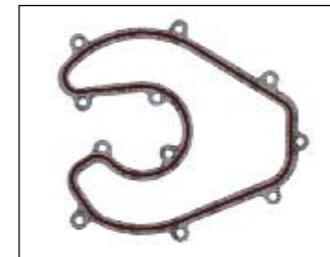

S610427021006
SIDE COVER GASKET



S610427108001
FLANGE GASKET
5830062



S610427108002
FLANGE GASKET
5830061



S610427108003
FLANGE GASKET

APPLICATIONS APPLICAZIONI	YEAR ANNO	FULL GASKET KIT KIT G.NI MOTORE	TOP-END GASKET KIT KIT G.NI SMERIGLIO	ENGINE OIL SEAL KIT KIT PARAOLIO	HEAD GASKET GUARNIZIONI TESTA	BASE GASKET GUARNIZIONI BASE
580	88-91	P600440850500	P600440600500	NA	S510440001003 EST	S610440006002
	92 & up	P600440850501	P600440600501		OR M752008300094 INT	S610440006007
650	ALL	P600440850650	P600440600650	P600440400650	S610440001001 EST OR M752008300094 INT	S610440006004
720	ALL	P600440850720	P600440600720	P600440400720	S610440001001 EST ORM752008800094 INT	S610440006003
800 carb. Motor	ALL	P600440850800	P600440600800	P600440400800	S610440001002 EST OR M752008800094 INT	S610440006005
800 RFI	ALL	P600440850003	NA	P600440400800	S610440001002 EXT OR M752008800094 INT	TBA
951 ROTAX	97	P600440850700		NA	S610440001003	S610440006012 (th 0,3) S610440006013 (th 0,5) S610440006014 (th 0,6)
	98	P600440850701		NA	S610440001003	S610440006015 (th 0,5) S610440006016 (th 0,8) S610440006017 (th 0,6)
951 CARB MOTOR	ALL	P600440850001	NA	P600440400001	S610440001003	S610440006015
951 DI	ALL	P600440850002	NA	P600440400001	S610440001004	S610440006015
1500 FOUR TECH	ALL	P600440850951	NA	NA		

GASKET KIT
KIT GUARNIZIONI



P600440400001 **NEW**



P600440400650



P600440400720



P600440400800 **NEW**

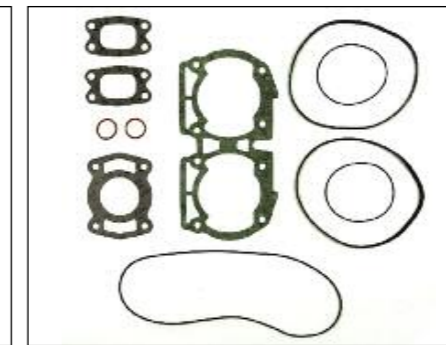

P600440600500

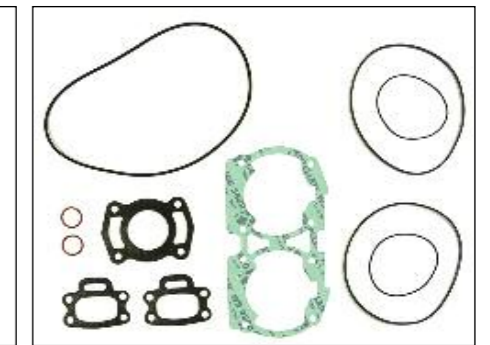

P600440600501

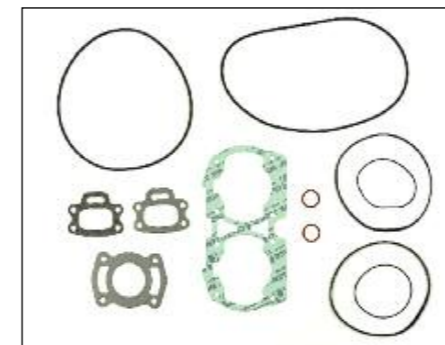

P600440600650

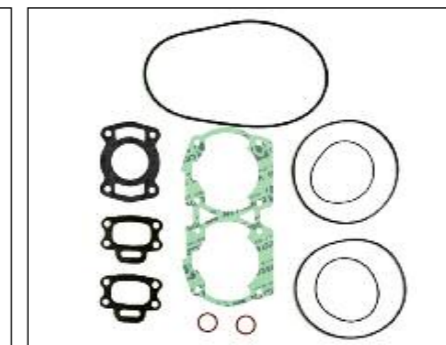

P600440600720

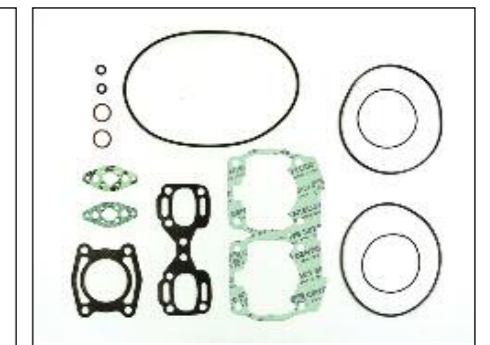

P600440600800

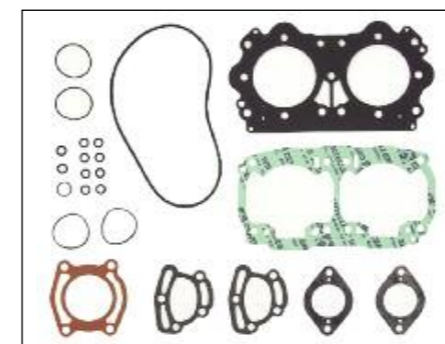

P600440850001 **NEW**

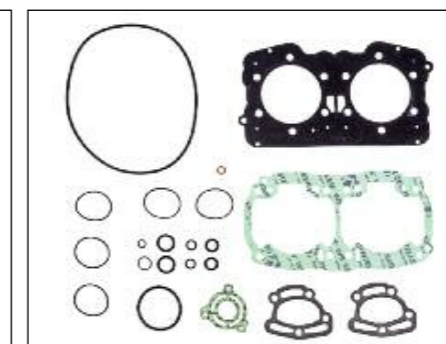

P600440850002 **NEW**

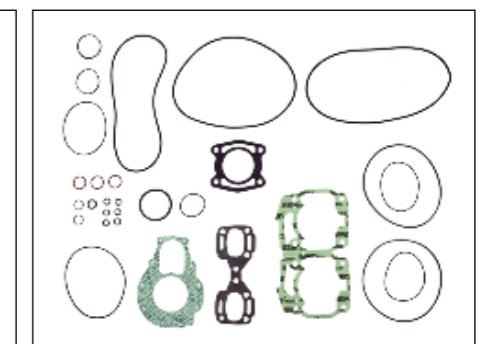

P600440850003 **NEW**

SEA-DOO JET SKI

SEA-DOO JET SKI

CUSTOMER SERVICE - SERVIZIO CLIENTI: info@athena-ad.com

CUSTOMER SERVICE - SERVIZIO CLIENTI: info@athena-ad.com

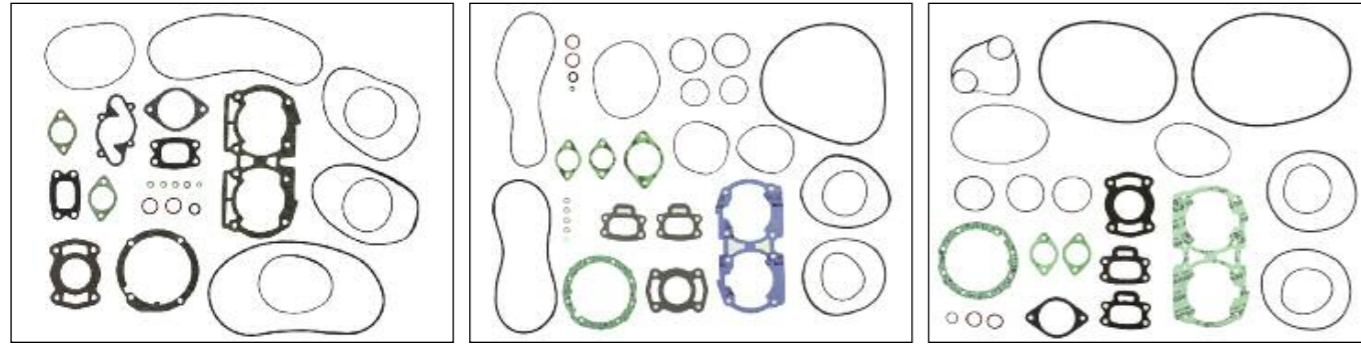

P600440850500

P600440850501

P600440850650

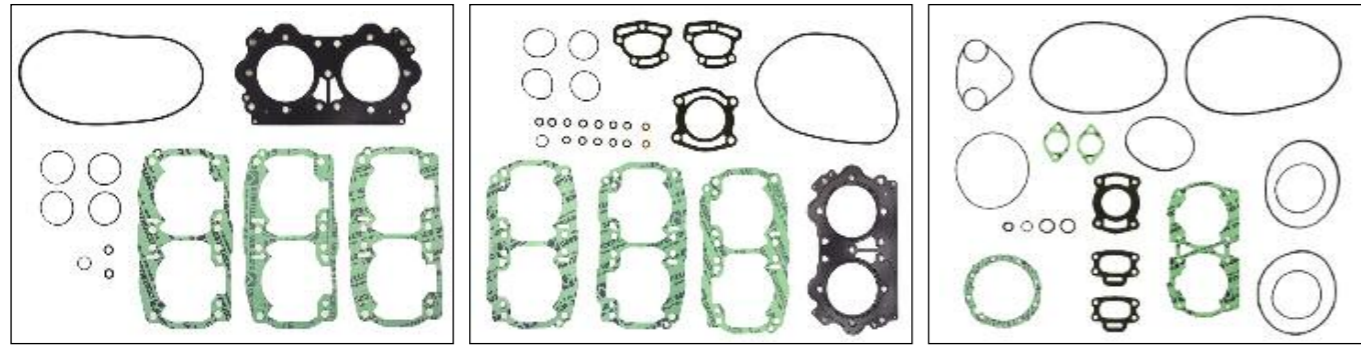

P600440850700

P600440850701

P600440850720

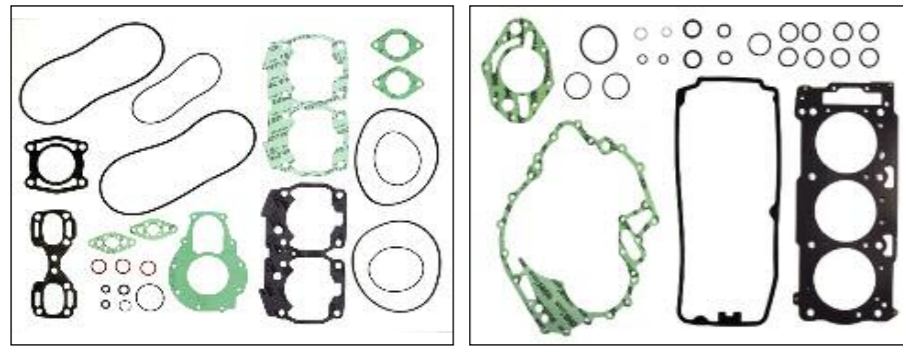

P600440850800

P600440850951

HEAD GASKET
GUARNIZIONI TESTA

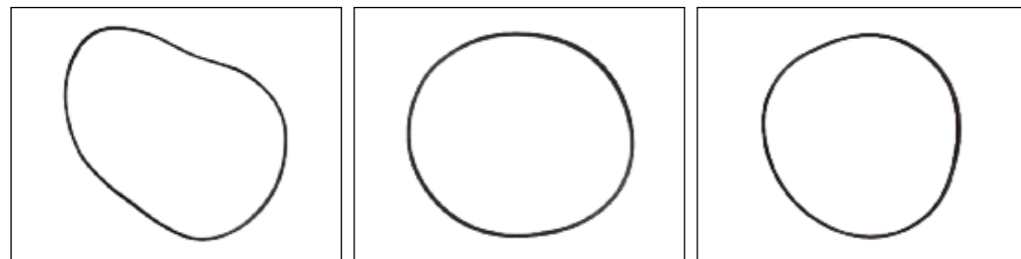

S510440001003
290-850-040

S610440001001
290-850-045

S610440001002
290-931-420



S610440001003
290-931-702

S610440001004
420-931-706

S610440001019
420-950-770

S610440006002
290-850-775

BASE GASKET
GUARNIZIONI BASE



S610440006015 sp. 0,5
290-931-685

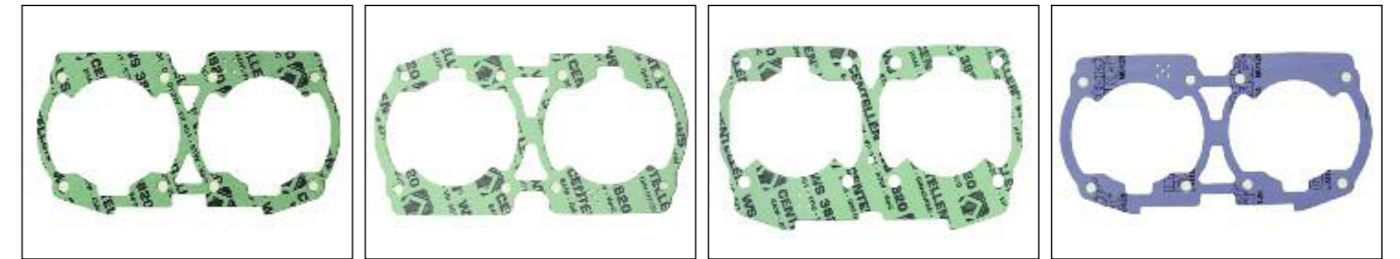

S610440006003
290-931-401

S610440006004
290-931-161

S610440006005
290-931-461

S610440006007
290-931-160

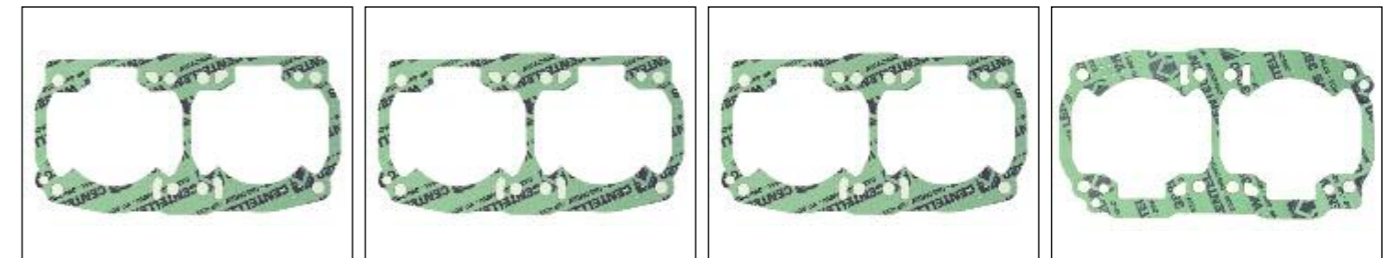

S610440006012 sp. 0,3
290-931-681

S610440006013

S610440006014 sp. 0,3

















S610440006016 sp. 0,8
290-931-687

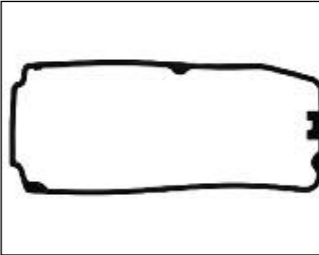

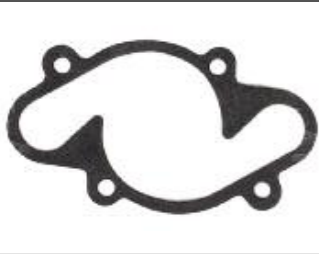
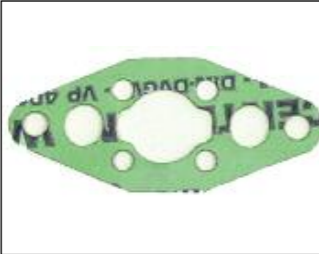
S610440006017 sp. 0,6
290-931-686

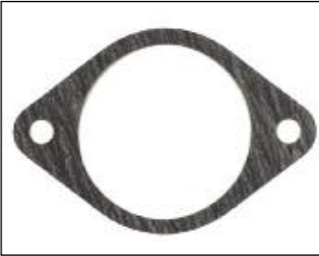

S610440006021
290-931-460

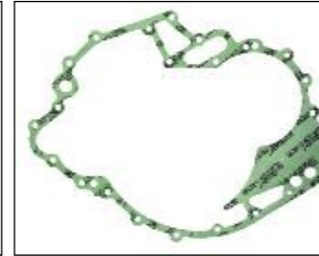
S610440006022
420-931-728

			
S610440010001 INTAKE GASKET 290-850-372	S610440010004 INTAKE GASKET 270-000-114	S610440012002 EXHAUST GASKET 290-850-630	S610440012004 EXHAUST GASKET 290-950-251
			
S610440012005 EXHAUST GASKET 290-850-637	S610440012006 EXHAUST MANIFOLD GASKET 420-931-481	S610440012007 EXHAUST GASKET 420-931-503	S610440012008 EXHAUST GASKET 293-250-081
			
S610440012009 EXHAUST GASKET 290-250-080	S610440015002 VALVE COVER GASKET 420-950-820	S610440017001 ALTERNATOR COVER GASKET 290-850-605	S610440017002 ALTERNATOR COVER GASKET -
			
S610440021001 WATER PUMP GASKET 290-831-615	S610440021002 WATER PUMP GASKET 290-931-540	S610440021003 WATER PUMP GASKET 290-931-470	S610440021007 WATER PUMP GASKET -
			
S610440021009 WATER PUMP GASKET -	S610440108001 FLANGE GASKET 290-830-905	S610440108003 FLANGE GASKET 270-500-384	S610440007001 SIDE COVER GASKET 420-931-130

APPLICAZIONI APPLICATIONS	YEAR ANNO	FULL GASKET KIT KIT G.NI MOTORE	TOP-END GASKET KIT KIT G.NI SMERIGLIO	ENGINE OIL SEAL KIT KIT PARAOLIO	HEAD GASKET GUARNIZIONI TESTA	BASE GASKET GUARNIZIONI BASE
639/644	ALL	P600510850001	NA	-	S610510001001	S610510006001
770	ALL	P600510850002	NA	-	S610510001002	S610510006002
900/1000/1100	ALL	P600510850003	NA	-	OR M751802500004 EXT OR M752508800074 INT	MAG S610510006003 CNT S610510006005 PTO S610510006004

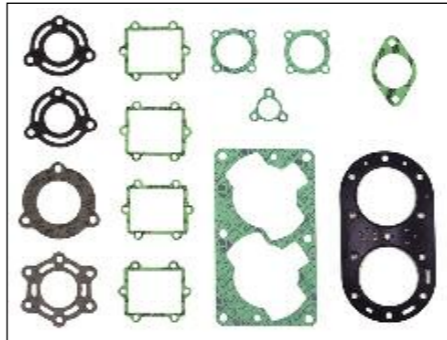
GASKET KIT
KIT GUARNIZIONI

	
P600510850001	P600510850002



S610510001001
3008436



S610510001002
3008635

BASE GASKET
GUARNIZIONI BASE

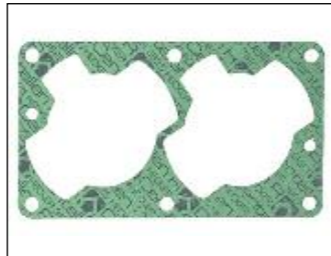

S610510006001
3008050

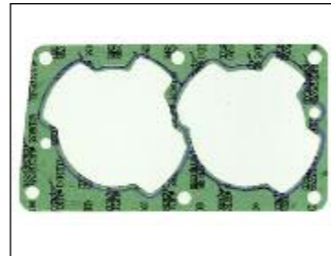

S610510006002
3008411

INDIVIDUAL GASKET
GUARNIZIONI SFUSE



S610485012036
EXHAUST GASKET
0612461



S610510010002
REED GASKET
3008076



S610510012001
EXHAUST GASKET
3008080



S610510012002
EXHAUST GASKET
3008081



S610510012003
EXHAUST MANIFOLD GASKET
3008434



S610510012006
EXHAUST GASKET
0612914



S610510012008
EXHAUST GASKET
3008082



S610510021001
COVER GASKET
3008058



S610510047001
COVER GASKET
1769198E30



S610510093004
CARBURETOR GASKET
0673090

APPLICATIONS APPLICAZIONI	YEAR ANNO	FULL GASKET KIT KIT G.NI MOTORE	TOP-END GASKET KIT KIT G.NI SMERIGLIO	ENGINE OIL SEAL KIT KIT PARAOLIO	HEAD GASKET GUARNIZIONI TESTA	BASE GASKET GUARNIZIONI BASE
500	87-93	P600485850500	P600485600500	NA	S610485001003	
650 WAVE RUNNER	90-93	P600485850601	P600485600601	NA	S610485001001	S610485006001/1
701 WAVE RAIDER	94-96	P600485850603	P600485600603	P600485400603	S610485001006	S610485006003
701 WAVE VENTURE	94-96	P600485850603	P600485600603	P600485400603	S610485001006	S610485006003
760	ALL	P600485850604	P600485600604		S610485001009	S610485006003/1
800	ALL	P600485850605	P600485600605	NA	S610485001011	S610485006006
1000	03	P600485850027	NA	NA	S610485001030	
1100	94-96	P600485850602	P600485600602	P600485400602	S610485001007	S610485006002
1100 WV FX	ALL	P600485850029	NA	NA	S610485001031	
1200 GP	ALL	P600485850900	P600485600900	NA	S610485001008	S610485006002
1200 R POWER VALVE	99-00	P600485850900	NA	NA	S610485001008	S610485006002
1200 R POWER VALVE	01 & up	P600485850606	NA	NA	S610485001012	
1200 GP R	01-02	P600485850606	P600485600606	P600485400603	S610485001012	
1300 POWER VALVE	03-04	P600485850032	P600485600032	NA	S610485001029	S610485006006
1300 NO POWER VALVE	05 & up	P600485850034	P600485600034	NA	S610485001032	S610485006006
FX 140	02-06	P600485850033	NA	NA	S610485001031	
VX 1100	05-08	P600485850028			S610485001034	

TIGER SHARK JET SKI

YAMAHA JET SKI

CUSTOMER SERVICE - SERVIZIO CLIENTI: info@athena-ad.com

CUSTOMER SERVICE - SERVIZIO CLIENTI: info@athena-ad.com



P60048540062



P60048540063

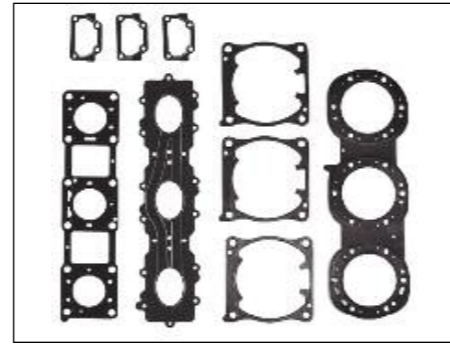

P60048560032



P60048560050



P60048560061

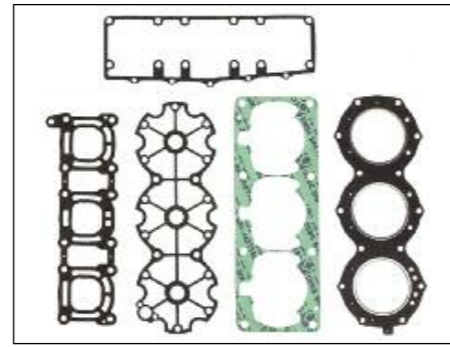

P60048560062

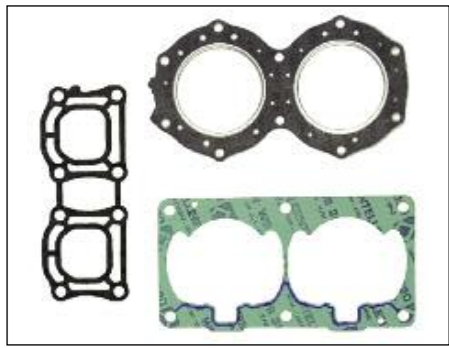

P60048560063



P60048560064



P60048560065



P60048560066

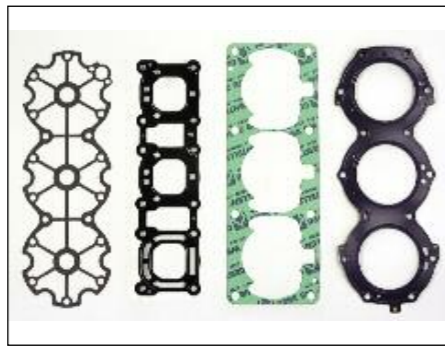

P60048560090

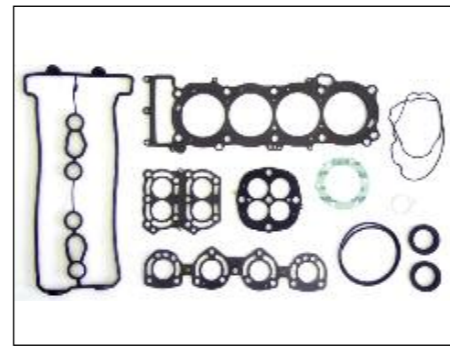

P600485850027

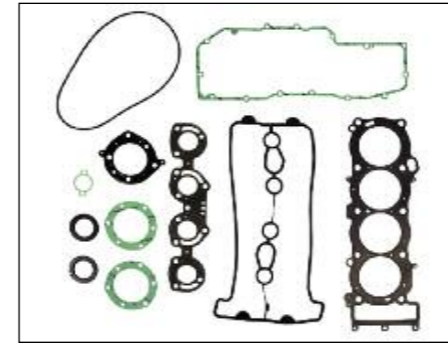

P600485850028

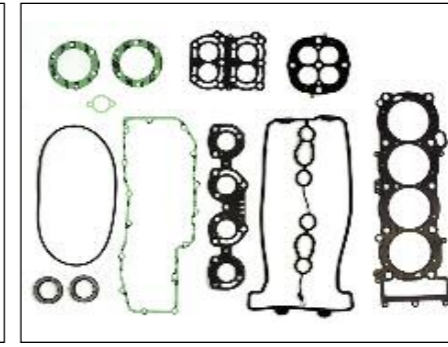

P600485850029

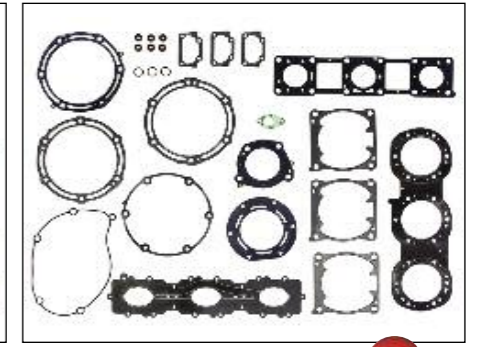

P600485850032

NEW

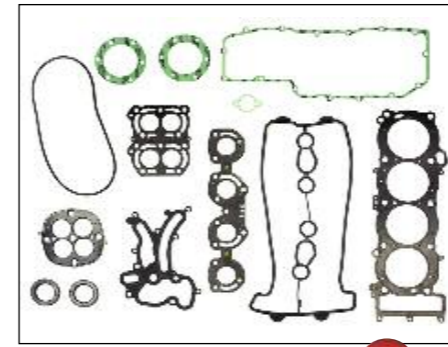

P600485850033

NEW



P600485850500

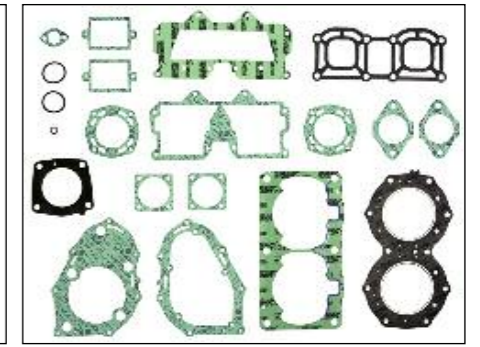

P600485850601

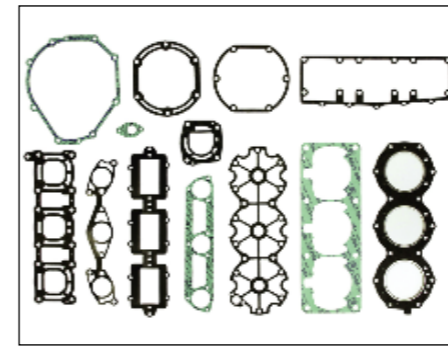

P600485850602



P600485850604



P600485850605

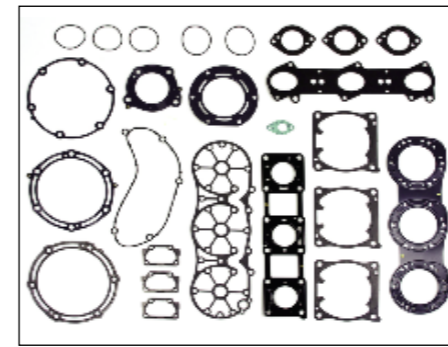

P600485850606

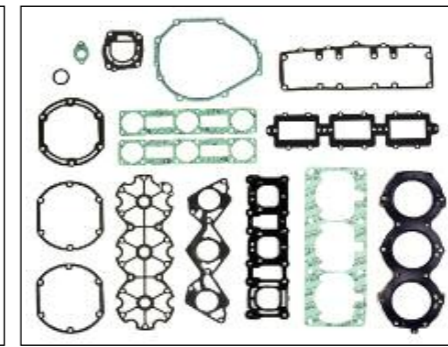

P600485850900



S610485001001
61X-11181-A0



S610485001003
6K8-11181-A1



S610485001006



S610485001007
63M-11181-01



S610485001008
65U-11181-01



S610485001009
64X-11181-00



S610485001011
66E-11181-00



S610485001012
66V-11181-01



S610485001013
66V-14739-00



S610485001014
66V-14623-00



S610485001029
60T-11181-00



S610485001030
60E-11181-00



S610485001031
6B6-11181-00



S610485001032
60T-11181-10



S610485001034
6D3-11181-00

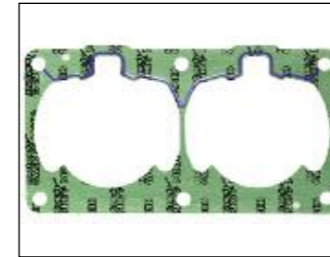

S61048500600/1
6M6-11351-A0

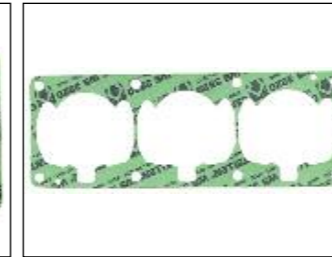

S610485006002
63M-11351-01



S610485006003/1
6M6-11351-A2



S610485006006
66E-11351-02

INDIVIDUAL GASKET
GUARNIZIONI SFUSE



S610485010001
INTAKE GASKET
6M6-13556-A1



S610485010002
INTAKE GASKET
6M6-13621-A1

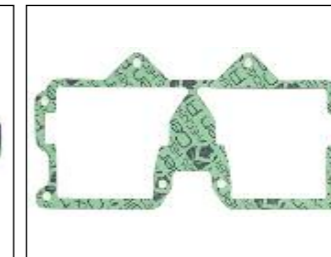

S610485010003
INTAKE MANIFOLD GASKET
6M6-13566-A1

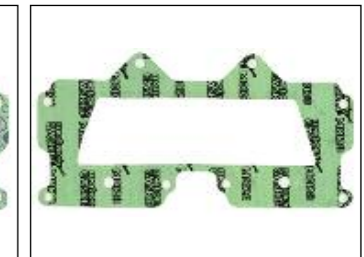

S610485010004
INTAKE MANIFOLD GASKET
6M6-13563-A1

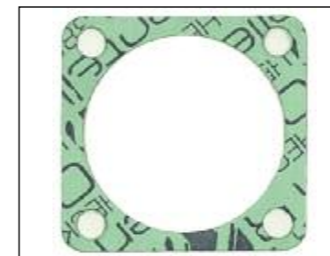

S610485010005
INTAKE GASKET
6M6-13674-A1



S610485010006
INTAKE GASKET
6M6-13556-A1

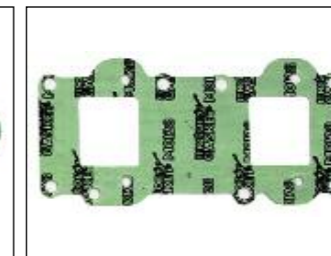

S610485010007
INTAKE MANIFOLD GASKET
6K8-13621-A1



S610485010008
INTAKE MANIFOLD GASKET
62T-13566-00



S610485010011
INTAKE MANIFOLD GASKET
63M-13674-00

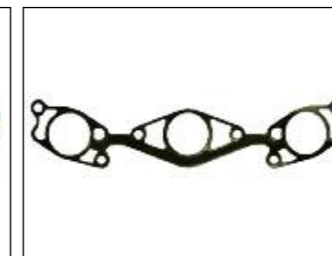

S610485010012
INTAKE MANIFOLD GASKET
63M-13556-00

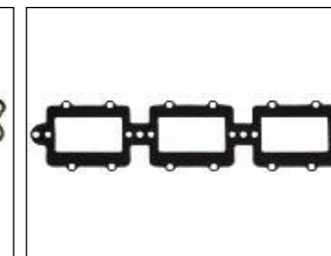

S610485010013
INTAKE MANIFOLD GASKET
63M-13566-00

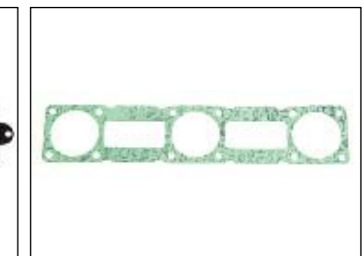

S610485010014
INTAKE MANIFOLD GASKET
65U-13674-00

YAMAHA JET SKI

YAMAHA JET SKI

CUSTOMER SERVICE - SERVIZIO CLIENTI: info@athena-ad.com

CUSTOMER SERVICE - SERVIZIO CLIENTI: info@athena-ad.com

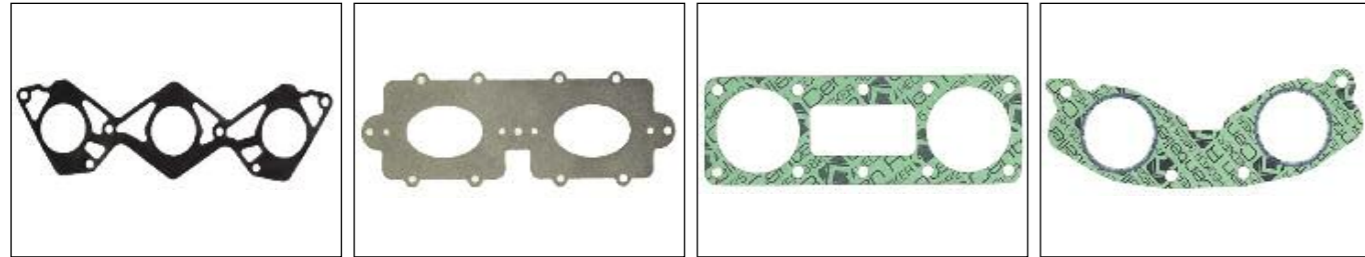

S610485010015 INTAKE MANIFOLD GASKET 65U-13556-00
S610485010017 INTAKE MANIFOLD GASKET 39X-13621-01
S610485010018 INTAKE MANIFOLD GASKET 64X-13674-00
S610485010019 INTAKE MANIFOLD GASKET 64X-13556-00



S610485010020 INTAKE MANIFOLD GASKET 66V-13556-00
S610485010021 INTAKE MANIFOLD GASKET 66E-13556-00
S610485010059 INTAKE MANIFOLD GASKET 60T-13556-00
S610485012002 EXHAUST MANIFOLD GASKET 6M6-14613-A0

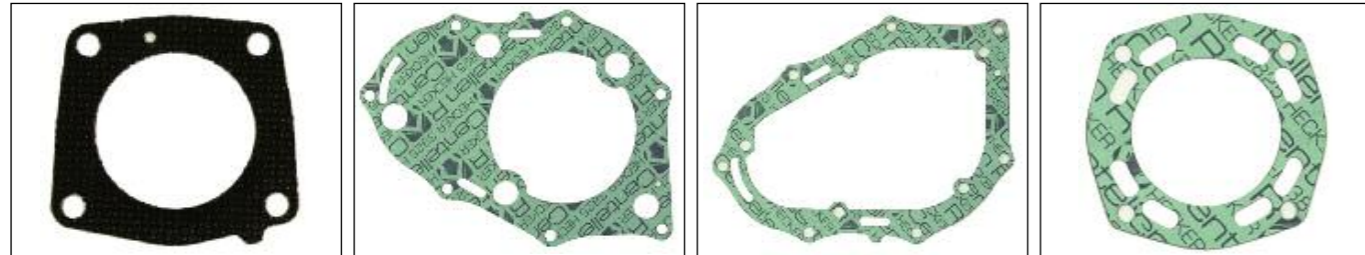

S610485012003 EXHAUST GASKET 6R7-14749-A0
S610485012004 EXHAUST GASKET 6R7-41114-A0
S610485012005 EXHAUST GASKET 6R7-14755-A0
S610485012006 EXHAUST GASKET 6M6-14739-A1

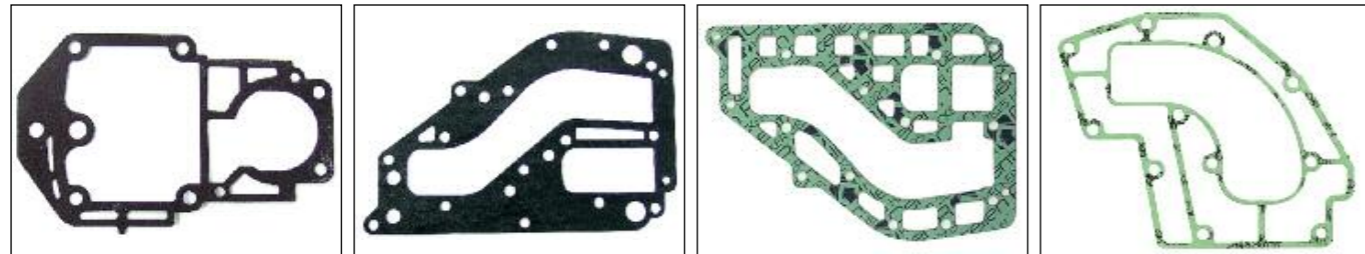

S610485012010 EXHAUST GASKET 61T-45113-A0
S610485012011 EXHAUST GASKET 6K8-41124-A1
S610485012012 EXHAUST GASKET 6K8-41122-A1
S610485012013 EXHAUST GASKET 6K8-41114-A1

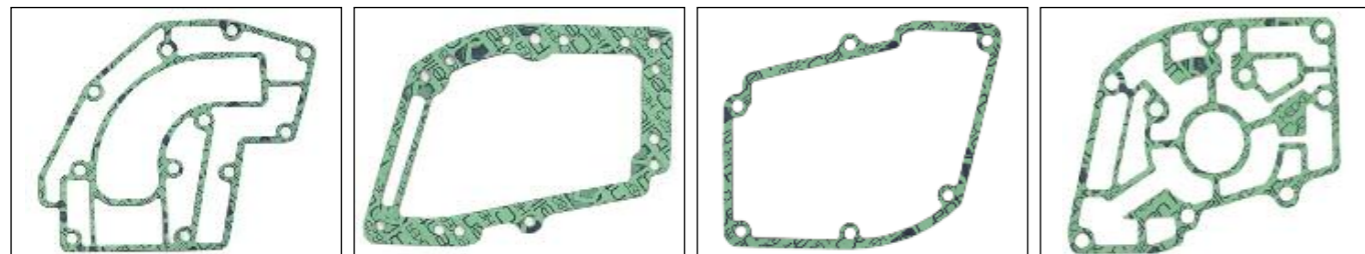

S610485012014 EXHAUST GASKET 61T-41112-A1
S610485012015 EXHAUST GASKET 6K8-14739-A1
S610485012016 EXHAUST GASKET 6K8-14749-00
S610485012017 EXHAUST GASKET 6K8-14755-A1

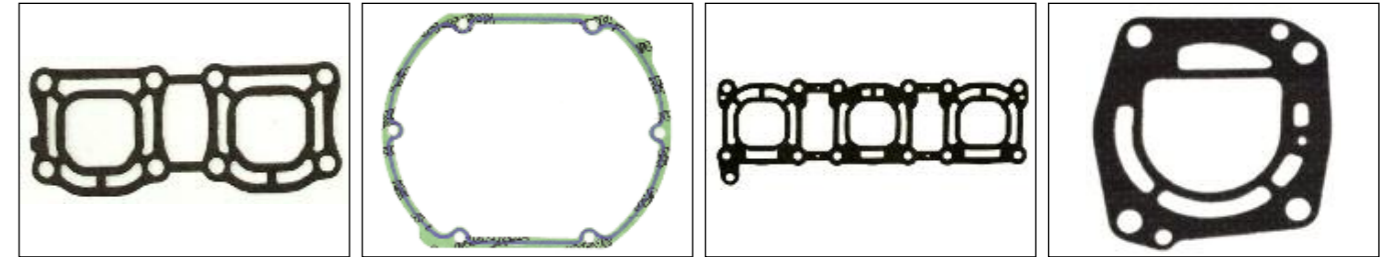

S610485012019 EXHAUST GASKET 62T-14613-00
S610485012022 EXHAUST GASKET 62T-41114-01
S610485012024 EXHAUST MANIFOLD GASKET 63M-14613-00
S610485012025 EXHAUST GASKET 63M-14749-00

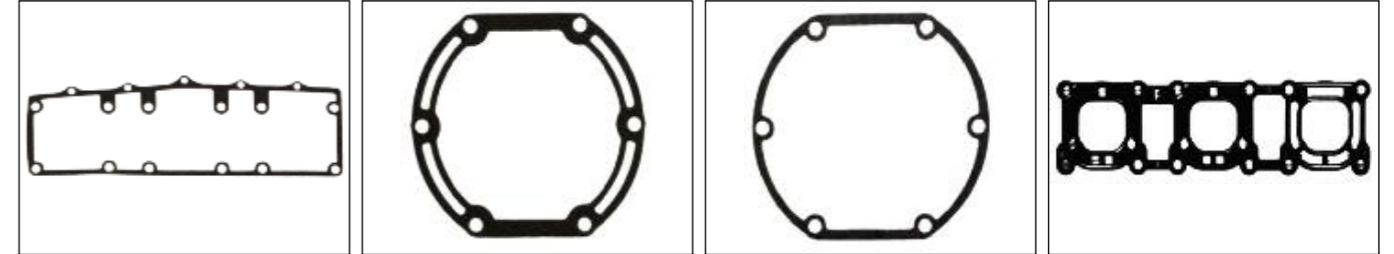

S610485012026 EXHAUST GASKET 63M-14739-00
S610485012027 EXHAUST GASKET 63M-41122-00
S610485012028 EXHAUST GASKET 63M-41114-00
S610485012029 EXHAUST MANIFOLD GASKET 65U-14613-00

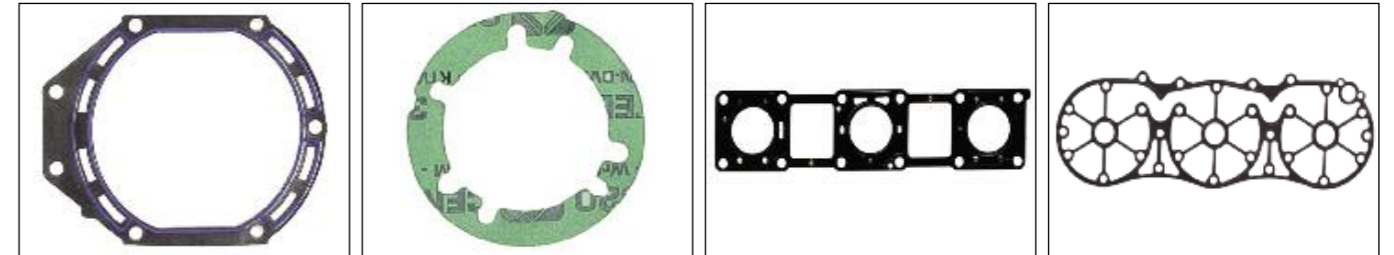

S610485012032 EXHAUST GASKET 64X-41124-00
S610485012033 EXHAUST GASKET 64X-14623-00
S610485012034 EXHAUST MANIFOLD GASKET 66V-14613-01
S610485012035 EXHAUST MANIFOLD GASKET 66V-11193-01

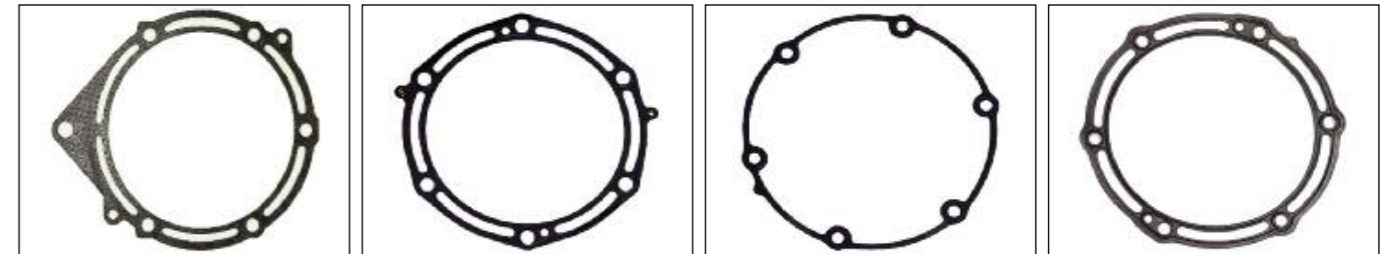

S610485012037 EXHAUST GASKET 66E-41124-10
S610485012038 EXHAUST GASKET 66V-14749-00
S610485012039 EXHAUST GASKET 66V-41114-00
S610485012040 EXHAUST GASKET 66V-41124-00



S610485012041 EXHAUST MANIFOLD GASKET 66E-14613-00
S610485012042 EXHAUST GASKET 66E-14749-00
S610485012082 EXHAUST MANIFOLD GASKET 60E-14613-00
S610485012084 EXHAUST MANIFOLD GASKET 6D3-14613-00



S610485012085
EXHAUST GASKET
6D3-14739-00

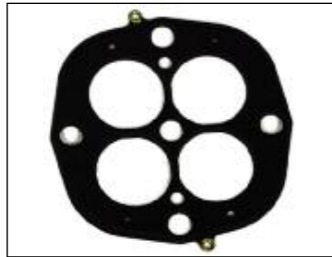

S610485012086
EXHAUST GASKET
60E-14749-01

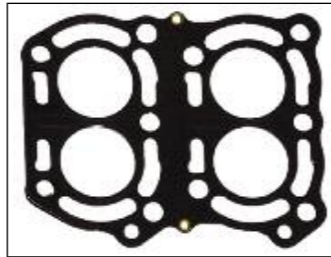

S610485012087
EXHAUST GASKET
60E-14739-01

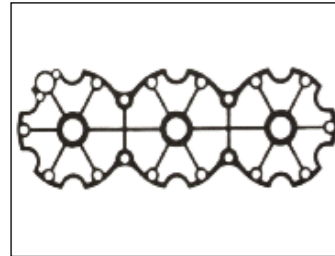

S610485015002
HEAD COVER GASKET
63M-11193-00

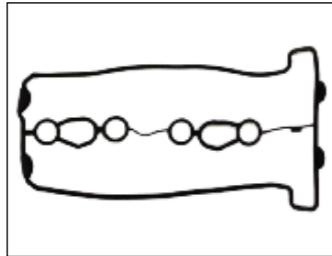

S610485015013
VALVE COVER GASKET
60E-11193-00



S610485017002
GENERATOR COVER GASKET
6M6-81365-A0

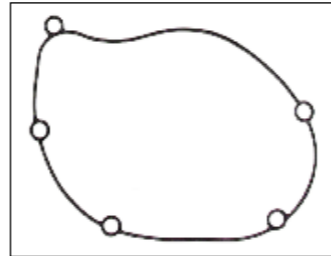

S610485017003
GENERATOR COVER GASKET
66V-81168-10



S610485018001
COVER GASKET
6K8-15369-A1



S610485021001
COVER GASKET
655-12414-00

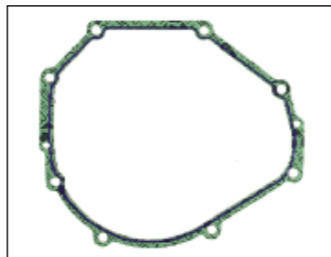

S610485021004
SIDE COVER GASKET
63M-81365-00



S610485021006
VALVE INSPECTION GASKET
66E-1131B-01



S610485021007
COVER GASKET
66E-14623-00



S610485024001
WATER PUMP GASKET
63M-13116-00

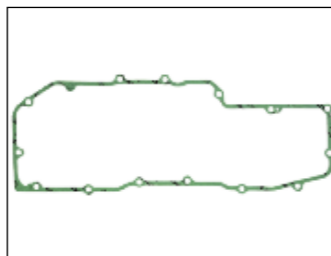

S610485026004
OIL PAN GASKET
6B6-13557-00

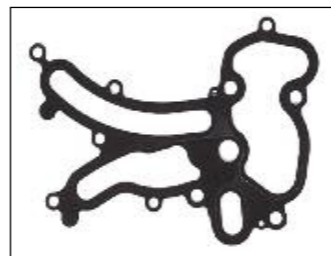

S610485051001
OIL PUMP GASKET
6B6-13563-01



S610485108001
FLANGE GASKET
6R8-13116-A0



S610485108002
FLANGE GASKET
66E-14398-00



S610485108010
FLANGE GASKET
6FM-12213-00



S610485021002
COVER GASKET
6K8-13674-A1

ATHENA #	OEM #	PAGE	ATHENA #	OEM #	PAGE	ATHENA #	OEM #	PAGE
P600245850001	439085	13	P600250850400		74	P600334850037	27-814195A97	27
P600245850002	391988	13	P600250850401		74	P600334850038	27-832934A00	27
P600245850003	393433	13	P600250850500		74	P600334850039	27-832934A00	27
P600245850004	437779	13	P600250850501		74	P600334850040	27-804985A1	27
P600245850005	437155	13	P600250850502		74	P600334850041	27-14697A87	27
P600245850006	432570	13	P600250850600		74	P600334850042	27-887810A04	27
P600245850007	439202	13	P600250850700		74	P600334850043	27-841220A03	27
P600245850008	390078	13	P600250850702		74	P600334850044	27-814658A98	27
P600245850009	398047	13	P600250850900		74	P600334850045	27-885214A1	27
P600245850010	5000400	13	P600334850002	27-809748A1	6	P600334850046	27-889439A01	27
P600245850011	436891	13	P600334850003	27-809750A1	6	P600334999001	27-815791A92	25
P600245850012	392615	13	P600334850004	27-43004A99	25	P600393400001		42
P600245850013	394546	14	P600334850005	27-13461A99	25	P600393850001		42
P600245850014	396750	14	P600334850006	27-814195A93	25	P600393850002		42
P600245850015	434381	14	P600334850007	27-90484A88	25	P600393850003		42
P600245850019	436891	14	P600334850008	27-85653A87	25	P600427600004		79
P600245850020	N.A.	14	P600334850009	27-812867A91	25	P600427600005		79
P600245850021	390700	14	P600334850010	27-69524A75	25	P600427600006		79
P600245850022	388602	14	P600334850011	27-73645A87	25	P600427600009		79
P600245850023	398172	14	P600334850012	27-72486A32	25	P600427850001		79
P600245850024	437725	14	P600334850013	27-809755A1	6	P600427850002		79
P600245850025	N.A.	14	P600334850014	27-41499A88	25	P600427850003		80
P600245850026	398693	14	P600334850015	27-11338A88	25	P600427850004		80
P600245850027	398355	14	P600334850016	27-78028A78	26	P600427850005		80
P600250400001		72	P600334850017	27-88449A32	26	P600427850006		80
P600250400004		72	P600334850018	27-85491A90	26	P600427850007		80
P600250400900		72	P600334850019	27-809751A1	6	P600427850008		80
P600250600001		72	P600334850020	27-809746A1	6	P600427850009		80
P600250600004		72	P600334850021	27-820751A2	6	P600440400001		83
P600250600005		72	P600334850022	27-820724A2	6	P600440400650		83
P600250600260		72	P600334850023	27-809122A2	6	P600440400720		83
P600250600300		72	P600334850024	27-820725A1	6	P600440400800		83
P600250600400		72	P600334850024	27-809748A1	6	P600440600500		83
P600250600401		72	P600334850025	27-82059A1	6	P600440600501		83
P600250600500		73	P600334850025	27-809469A2	6	P600440600650		83
P600250600502		73	P600334850026	27-809125A2	6	P600440600720		83
P600250600600		73	P600334850027	27-809817A1	6	P600440600800		83
P600250600700		73	P600334850028	27-822420A94	26	P600440850001		83
P600250600900		73	P600334850029	27-879855A04	26	P600440850002		83
P600250850001		73	P600334850030	27-81475A00	26	P600440850003		83
P600250850002		73	P600334850031	27-79583A9	26	P600440850500		84
P600250850003		73	P600334850032	27-850396A1	26	P600440850501		84
P600250850004		73	P600334850033	27-804852A1	26	P600440850650		84
P600250850005		73	P600334850034	27-89221A80	26	P600440850700		84
P600250850006		73	P600334850035	27-883298A1	26	P600440850701		84
P600250850300		73	P600334850036	N.A.	26	P600440850720		84

YAMAHA JET SKI

CROSS REFERENCE LIST

CUSTOMER SERVICE - SERVIZIO CLIENTI: info@athena-ad.com

CUSTOMER SERVICE - SERVIZIO CLIENTI: info@athena-ad.com

ATHENA #	OEM #	PAGE	ATHENA #	OEM #	PAGE	ATHENA #	OEM #	PAGE
P600440850800		84	P600485850032		91	S610245001016	336361	15
P600440850951		84	P600485850033		91	S610245001017	332010	15
P600485400602		90	P600485850500		91	S610245001018	307069	15
P600485400603		90	P600485850601		91	S610245001019	325273	15
P600485600032		90	P600485850602		91	S610245001020	329103	15
P600485600500		90	P600485850604		91	S610245001021	338222	15
P600485600601		90	P600485850605		91	S610245001022	329786	15
P600485600602		90	P600485850606		91	S610245001023	322332	15
P600485600603		90	P600485850900		91	S610245006001	329975	16
P600485600604		90	P600510850001		87	S610245006002	330621	16
P600485600605		90	P600510850002		87	S610245006003	326468	16
P600485600606		90	P700337850001	27-34213A2	59	S610245006004	328590	16
P600485600900		90	P700337850003	N.A.	59	S610245006005	328618	16
P600485850001	6H4-W0001-A1-00	46	P700337999002	27-34213A2	59	S610245006006	329828	16
P600485850002	6H3-W0001-00-00	46	P700337999004	N.A.	59	S610245006007	333879	16
P600485850003	6G5-W0001-03-00	46	P700337999005	N.A.	59	S610245006008	325721	16
P600485850004	61A-W0001-01-00	46	P700337999006	27-11977A88	59	S610245006009	324717	16
P600485850005	6F3-W0001-A4-00	46	P700337999007	N.A.	60	S610245006010	318373	16
P600485850006	6H1-W0001-00-00	46	P700337999009	27-94996Q2	60	S610245006011	347205	16
P600485850006	6H1-W0001-A0-00	46	P700337999010	27-35996A1	60	S610245010001	321907	17
P600485850007	68F-W0001-01-00	46	P700600850001		66	S610245010002	319174	17
P600485850008	6A0-W0001-21-00	46	P700600850002		66	S610245010003	328622	17
P600485850009	6G1-W0001-A2-00	46	P700600850003		66	S610245010004	331532	17
P600485850010	6G8-W0001-A3-00	46	P700600850004		66	S610245010005	335633	17
P600485850011	65W-W0001-20-00	46	P700600850005		66	S610245010006	344526	17
P600485850012	67C-W0001-20-00	46	P700600850006		66	S610245010007	336227	17
P600485850013	682-W001-06-00	47	P700600850007		66	S610245010008	336226	17
P600485850014	66M-W0001-20-00	47	P700600850008		66	S610245010009	336389	17
P600485850015	67C-W0001-00-00	47	P700600850009		66	S610245010010	336388	17
P600485850016	65W-W0001-00-00	47	P700600850010		66	S610245010011	335403	17
P600485850017	61T-W0001-02-00	47	S410250015053	11061-0090	78	S610245010012	335818	17
P600485850017	689-W0001-04-00	47	S510427108001	3082937	81	S610245010013	335404	18
P600485850018	63D-W0001-20-00	47	S510440001003	290-850-040	84	S610245010014	335819	18
P600485850019	66M-W0001-01-00	47	S610245001001	318358	15	S610245010015	344335	18
P600485850020	63D-W0001-00-00	47	S610245001002	335360	15	S610245010016	326926	18
P600485850021	67c-w0001-20-00	47	S610245001003	335359	15	S610245010017	317305	18
P600485850022	6L2-W0001-C3-00	47	S610245001004	27-41246-1	28	S610245010018	332266	18
P600485850023	61N-W0001-E1-00	47	S610245001005	329836	15	S610245012001	317955	18
P600485850024	6L2-W0001-03-00	47	S610245001007	334726	15	S610245012002	317914	18
P600485850024	6L2-W0001-02-00	47	S610245001009	333554	15	S610245012003	323469	18
P600485850025	6R6-W0001-02-00	48	S610245001010	329419	15	S610245012004	321182	18
P600485850026	6G1-W0001-C1-00	48	S610245001011	346007	15	S610245012005	321435	18
P600485850027		90	S610245001012	313413	15	S610245012006	N.A.	16
P600485850028		91	S610245001013	330818	15	S610245012006	339601	18
P600485850029		91	S610245001014	328623	15	S610245012007	339601	17
P600485850031	6D0-W0001-00-00	48	S610245001015	331211	15	S610245012008	307133	18

ATHENA #	OEM #	PAGE	ATHENA #	OEM #	PAGE	ATHENA #	OEM #	PAGE
S610245012009	325211	18	S610245024004	338484	20	S610250012009	11009-3777	76
S610245012010	331917	18	S610245047001	318925	20	S610250012010	11009-2446	76
S610245012011	331916	18	S610245047002	319332	20	S610250012011	11009-3778	76
S610245012012	329833	18	S610245093001	327707	20	S610250012012	11009-3788	76
S610245012013	336430	18	S610245093002	325092	21	S610250012013	11009-3722	76
S610245012014	336429	18	S610245093007	331363	21	S610250012014	11009-3723	77
S610245012015	318156	18	S610245108001	303615	21	S610250012015	92065-515	77
S610245012016	304762	18	S610245108002	N.A.	21	S610250012016	11009-3708	77
S610245012017	319348	19	S610245117001	303355	21	S610250012017	11009-3750	77
S610245015001	321727	17	S610245140001	321722	21	S610250012018	11009-3744	77
S610245015002	335503	17	S610245140002	321183	21	S610250012020	11060-3756	77
S610245015003	323222	19	S610245150001	310058	21	S610250012021	11060-3754	77
S610245021001	332369	19	S610245150002	329830	21	S610250012022	11060-3757	77
S610245021002	319174	19	S610250001001	11004-3709	74	S610250012023	11060-3769	77
S610245021003	318335	19	S610250001003	11004-3708	74	S610250012024	11060-3732	77
S610245021004	319771	19	S610250001004	11004-3716	74	S610250012026	11060-3718	77
S610245021005	307133	19	S610250001005	11004-3019	74	S610250012027	11060-3767	77
S610245021006	321184	19	S610250001006	11004-3008	75	S610250012028	11061-3713	77
S610245021007	324323	19	S610250001007	11004-3703	75	S610250012029	11061-3714	77
S610245021008	321479	19	S610250001009	11004-3706	75	S610250012036	11060-3785	77
S610245021009	320679	19	S610250001010	11004-3713	75	S610250012037	11060-3786	77
S610245021010	321497	19	S610250001012	11004-3717	75	S610250012043	11060-3768	77
S610245021011	323338	19	S610250001013	11004-3715	75	S610250012047	11061-3760	77
S610245021012	331598	19	S610250001014	11004-3714	75	S610250012048	11061-3762	77
S610245021013	326234	19	S610250001015	11004-3720	75	S610250012049	11061-3742	78
S610245021014	319661	19	S610250001019	11004-3722	75	S610250017002	11061-3709	78
S610245021015	342291	19	S610250001020	11004-3721	75	S610250021001	11009-3779	78
S610245021016	315538	19	S610250006001	11009-3782	75	S610250021003	11060-3744	78
S610245021017	331101	19	S610250006002	11009-3711	75	S610250021004	11060-3723	78
S610245021018	330412	19	S610250006004	11009-3706	75	S610250026001	11061-3710	78
S610245021019	332319	20	S610250006005	11009-3752	75	S610250093002	11060-3784	78
S610245021020	321794	20	S610250006007	11060-3783	75	S610250093003	11060-3761	78
S610245021021	333008	20	S610250006008	11060-3760	75	S610250108002	11060-3716	78
S610245021022	318609	20	S610250006009	11061-3708	75	S610250108005	11060-3776	78
S610245021023	329920	20	S610250010001	16062-510	76	S610334001001	27-820438	7
S610245021024	325260	20	S610250010002	11060-3703	76	S610334001002	27F476529-4	7
S610245021025	318924	20	S610250010005	11060-3717	76	S610334001002	27-824615	7
S610245021026	328604	20	S610250010007	11060-3716	76	S610334001003	340115	16
S610245021028	N.A.	20	S610250010008	11061-3738	76	S610334001005	27-96542-1	28
S610245021029	337068	20	S610250010010	11061-3737	76	S610334001006	27-795831	28
S610245021030	311365	20	S610250012003	11060-3759	76	S610334001007	27-822844-1	28
S610245021031	311364	20	S610250012004	11060-3721	76	S610334001009	27-814658-1	28
S610245021032	304784	20	S610250012005	11060-3730	76	S610334001010	27-814658-75	28
S610245024001	317951	20	S610250012006	11060-3728	76	S610334001011	27-18785-1	28
S610245024002	321028	20	S610250012007	11060-3726	76	S610334001012	27-852520-3	28
S610245024003	322858	20	S610250012008	11060-3727	76	S610334001013	7-691529-1	7

ATHENA #	OEM #	PAGE	ATHENA #	OEM #	PAGE	ATHENA #	OEM #	PAGE
S610334001014	27-F658529	7	S610334010005	N.A.	8	S610334012018	27-41813	32
S610334001015	27-18786-1	28	S610334010005	27-F844725	30	S610334012019	N.A.	32
S610334001016	27-41670-3	28	S610334010006	27-134612	30	S610334012020	27-87105-1	32
S610334001017	858452-1	28	S610334010007	328826	21	S610334012021	N.A.	32
S610334001018	69J-11182-03-00	49	S610334010007	27-65744-3	30	S610334012022	27-999177	32
S610334001018	27-887848-1	28 49	S610334010008	27-657442	21	S610334012023	N.A.	32
S610334001019	69J-11181-03-00	49	S610334010008	27-657442	30	S610334012024	27-85497-2	32
S610334001019	27-887848	28 49	S610334010009	27-812868	31	S610334012025	27-854922	32
S610334001020	27-858081	28	S610334010011	27-814895-1	31	S610334012026	27-75909	30
S610334001021	27-41245-1	28	S610334010012	27-819113	8	S610334012028	N.A.	8
S610334001022	25-818573	28	S610334010012	27-819133	31	S610334012029	27-819023 1	8
S610334001023	25-884391	28	S610334010013	27-27936-1	31	S610334012030	27-855874	33
S610334006001	27-819381	7	S610334010014	27-819114-1	8	S610334015001	N.A.	8
S610334006002	27-430073	29	S610334010014	27-8191141	31	S610334015001	N.A.	33
S610334006003	27-79650-1	29	S610334010015	N.A.	8	S610334015002	N.A.	8
S610334006004	27-826738	29	S610334010015	N.A.	31	S610334015002	N.A.	33
S610334006005	27-826549	7	S610334010016	N.A.	8	S610334015003	6G5-451130-A0-00	50
S610334006005	27-82687-1	29	S610334010016	N.A.	31	S610334015006	29-818574	33
S610334006006	27-82687-1	7	S610334010017	27-657442	31	S610334021001	27-78690	33
S610334006007	27-F307279-2	7	S610334010018	27-93536	31	S610334021002	769525	33
S610334006008	N.A.	7	S610334010019	27-64941	31	S610334021003	27-F85154-1	8
S610334006009	N.A.	7	S610334010020	27-73645	31	S610334021003	27-F85154-1	33
S610334006010	27-856542-1	29	S610334010021	27-12775-4	31	S610334021004	27-F85154-4	8
S610334006011	27-813932-2	29	S610334010023	27-55279-1	31	S610334021004	27-F85154-4	33
S610334006012	27-99176-1	29	S610334010024	27-880122	31	S610334021005	27-F85748-2	8
S610334006013	27-69238-1	29	S610334010025	27-879840	31	S610334021005	27-F85748-2	33
S610334006015	27-828553	29	S610334010026	27-821370	31	S610334021006	27-F85472-2	8
S610334006016	27-60317	29	S610334010027	27-804680	31	S610334021006	27-F85472-2	33
S610334006017	27-88451-1	29	S610334012001	27-99176-1	29	S610334021007	27-F686472	8
S610334006020	N.A.	29	S610334012002	27-18307-1	31	S610334021007	27-F686472	33
S610334006021	27-43337-4	29	S610334012003	27-99173-2	31	S610334021008	27-819024-2	8
S610334006022	27-82314-2	29	S610334012004	27-43004-7	31	S610334021008	27-819024-2	33
S610334006023	27-62680-1	29	S610334012005	N.A.	32	S610334021009	27-43005-7	33
S610334006024	27-892319001	29	S610334012006	27-812775	32	S610334021010	27-43006-2	33
S610334006025	27-887810011	29	S610334012007	27-812775-1	32	S610334021011	N.A.	33
S610334006026	27-F684453-1	7	S610334012008	323459	32	S610334021012	27-44328-4	33
S610334006027	27-819049-3	7	S610334012009	27-819381-4	7	S610334021013	344472	21
S610334006028	27-832933-5	29	S610334012010	27-69525-2	32	S610334021013	344472	33
S610334006029	27-75909	29	S610334012011	27-69524-2	32	S610334021014	N.A.	33
S610334010001	27-16737-1	30	S610334012012	27-85491-3	32	S610334021015	27-43779-2	33
S610334010002	27-F85159-1	8	S610334012013	27-85492-2	32	S610334021016	321573	21
S610334010002	27-F85159-1	30	S610334012014	N.A.	32	S610334021016	321573	33
S610334010003	27-F406406	8	S610334012015	N.A.	32	S610334021017	27-43777-2	34
S610334010003	27-F406406	30	S610334012016	27-33395	32	S610334021018	27-672741	34
S610334010004	27-F84748-3	8	S610334012017	27-832933-5	30	S610334021019	27-73645	34
S610334010004	27-F84748-3	30	S610334012017	27-99757	32	S610334021020	27-38501-1	34

ATHENA #	OEM #	PAGE	ATHENA #	OEM #	PAGE	ATHENA #	OEM #	PAGE
S610334021021	N.A.	8	S610334021065	N.A.	36	S610334047010	332108	21
S610334021021	N.A.	34	S610334021066	N.A.	36	S610334047010	332108	38
S610334021022	27-85487	34	S610334021067	N.A.	36	S610334047011	313416	21
S610334021023	27-825815	34	S610334021068	27-43779-2	36	S610334047011	313416	38
S610334021024	27-812861-1	34	S610334021069	27-76862-1	36	S610334047012	N.A.	38
S610334021025	27-828292	34	S610334021070	27-85488-2	36	S610334047013	N.A.	38
S610334021026	N.A.	34	S610334021071	27-85489-2	36	S610334047014	27-96171-1	38
S610334021027	N.A.	34	S610334021072	27-85490-2	36	S610334047015	27-85493	38
S610334021028	27-70335-1	34	S610334021075	N.A.	36	S610334047016	N.A.	38
S610334021029	27-F93472-1	8	S610334021076	N.A.	36	S610334047017	SUB-184354	38
S610334021029	27-F93472-1	34	S610334021077	27-892320	36	S610334047018	N.A.	9
S610334021030	N.A.	9	S610334021078	27-887893	36	S610334047018	N.A.	38
S610334021030	N.A.	34	S610334021079	27-887825	36	S610334047019	27-F40279-1	9
S610334021031	N.A.	34	S610334021080	27-78246-1	36	S610334047019	27-F40279-1	38
S610334021032	27-F40154-4	9	S610334021081	27-827284	36	S610334047020	27-41499-5	38
S610334021032	27-F40154-4	34	S610334021082	27-880738	37	S610334047021	N.A.	38
S610334021033	27-F97067	9	S610334021083	27-65788	37	S610334047022	N.A.	38
S610334021033	27-F97067	34	S610334021084	27-76636	37	S610334047023	27-41499-1	38
S610334021034	27-90430	34	S610334021085	27-856452	37	S610334047024	27-41475-8	39
S610334021035	N.A.	34	S610334024001	327674	21	S610334047025	27-14621	39
S610334021036	27-856452-1	34	S610334024001	327674	37	S610334047027	27-847525-1	39
S610334021038	27-88907	35	S610334024002	27-820490	37	S610334047028	27-993163	39
S610334021039	27-90484-1	35	S610334024003	N.A.	37	S610334047029	27-75789	39
S610334021040	27-96278	35	S610334024004	27-85609-1	37	S610334047030	27-96761	39
S610334021041	N.A.	35	S610334024005	27-85610-1	37	S610334047031	N.A.	39
S610334021042	27-95185-3	35	S610334024006	27-77417	37	S610334047032	SUB-184354	39
S610334021043	27-72142-1	35	S610334024007	N.A.	37	S610334047033	N.A.	39
S610334021044	27-85653-1	35	S610334024008	27-32769	37	S610334047034	N.A.	39
S610334021045	N.A.	35	S610334024009	27-32770	37	S610334047035	N.A.	39
S610334021046	27-812867-2	35	S610334024010	27-19206-1	37	S610334047036	N.A.	39
S610334021047	N.A.	35	S610334024011	14479	37	S610334047037	27-814754	39
S610334021048	N.A.	35	S610334024012	64877	37	S610334047038	27-840484	39
S610334021050	27-64859	35	S610334024013	27-85608-1	37	S610334047039	27-146973	39
S610334021051	27-85498-1	35	S610334047001	27-16737-1	37	S610334047040	27-12775-5	39
S610334021052	27-73665	35	S610334047002	27-11338	37	S610334047041	27-834828	39
S610334021053	27-85496-1	35	S610334047003	27-81359	37	S610334047042	27-850283	39
S610334021054	27-76952	35	S610334047004	27-146972	38	S610334047043	27-850292	39
S610334021056	N.A.	35	S610334047005	27-F40223	9	S610334047044	27-850282	39
S610334021057	N.A.	35	S610334047005	27-F40223	38	S610334086001	SUB-187813	40
S610334021058	N.A.	35	S610334047006	N.A.	9	S610334086002	SUB-187813	40
S610334021059	N.A.	35	S610334047006	N.A.	38	S610334086003	SUB-187813	40
S610334021060	N.A.	36	S610334047007	27-F481836	9	S610334086004	SUB-187813	40
S610334021061	27-85087	36	S610334047007	N.A.	38	S610334086005	SUB-187807	40
S610334021062	27-41418-1	36	S610334047008	27-F372154-1	9	S610334086006	SUB-187807	40
S610334021063	27-41417-2	36	S610334047008	27-F372154-1	38	S610334086007	SUB-187804	40
S610334021064	N.A.	36	S610334047009	N.A.	38	S610334086008	SUB-187804	40

CROSS REFERENCE LIST

CROSS REFERENCE LIST

CUSTOMER SERVICE - SERVIZIO CLIENTI: info@athena-ad.com

CUSTOMER SERVICE - SERVIZIO CLIENTI: info@athena-ad.com

ATHENA #	OEM #	PAGE	ATHENA #	OEM #	PAGE	ATHENA #	OEM #	PAGE
S610334086009	SUB-187804	40	S610393021001	3C8-09082-0	43	S610440012006	420-931-481	86
S610334086010	SUB-187808	40	S610393047001		43	S610440012007	420-931-503	86
S610334086011	SUB-187803	40	S610393058001		43	S610440012008	293-250-081	86
S610334086012	SUB-187803	40	S610393058002		43	S610440012009	290-250-080	86
S610334086013	SUB-187803	40	S610393082001	3C8-02104-0	43	S610440017001	290-850-605	86
S610334086014	SUB-187809	40	S610393082002	3F3-02104-0	43	S610440021001	290-831-615	86
S610334093001	27-67751-1	40	S610393082003	3T9-02104-0	43	S610440021002	290-931-540	86
S610334093002	27-89221-1	40	S610393108001		43	S610440021003	290-931-470	86
S610334093003	27-F476067	40	S610393108002		43	S610440108001	290-830-905	86
S610334093004	27-F85168-2	40	S610393150001	3T9-0103208	43	S610440108003	270-500-384	86
S610334093005	27-819733	40	S610427001001	3240191	80	S610485001001	61X-11181-A0	92
S610334093006	27-F178168-1	9	S610427001002	3240213	80	S610485001003	6K8-11181-A1	92
S610334093006	27-F178168-1	40	S610427001003	3240251	80	S610485001004	697-11181-A0-00	48
S610334093007	27-88004	41	S610427006001	5811057	81	S610485001006	6E5-11181-02-00	48
S610334093008	27-18143-2	41	S610427006002	3240055	81	S610485001007	63M-11181-01	92
S610334093009	N.A.	41	S610427006004	5811784	81	S610485001008	65U-11181-01	92
S610334093010	N.A.	41	S610427010001		81	S610485001008	6G5-11181-A0-00	48
S610334108001	N.A.	9	S610427012001	5830051	81	S610485001009	64X-11181-00	92
S610334108001	325092	21	S610427012002	5811045	81	S610485001010	688-11181-A0-00	48
S610334108001	325092	41	S610427012003	5211489	81	S610485001011	66E-11181-00	92
S610334108002	27-F85762	9	S610427012004	5830038	81	S610485001012	66V-11181-01	92
S610334108002	N.A.	41	S610427012005	5211623	81	S610485001013	66V-14739-00	92
S610334108003	N.A.	9	S610427021001	5811145	81	S610485001014	66V-14623-00	92
S610334108003	N.A.	41	S610427021002	3240045	81	S610485001016	6H3-11181-01-00	48
S610334108004	N.A.	9	S610427021006		81	S610485001018	6H4-11181-00-00	48
S610334108004	27-98769-1	41	S610427108001	5830062	81	S610485001019	61A-11181-00-A0	48
S610334108005	N.A.	41	S610427108002	5830061	81	S610485001020	63F-11181-00	48
S610334108006	27-48164-1	41	S610427108003		81	S610485001021	6G8-11181-A1	48
S610334108007	27-75791-1	41	S610440001001	290-850-045	84	S610485001022	6E7-11181-A1	48
S610334108008	27-79797-1	41	S610440001002	290-931-420	84	S610485001023	67C-11181-01	48
S610334108009	27-73377-1	41	S610440001003	290-931-702	85	S610485001024	65W-11181-30	48
S610334108010	N.A.	41	S610440001004	420-931-706	85	S610485001025	61N-11181-A1	49
S610334108011	N.A.	41	S610440006003	290-931-401	85	S610485001026	66M-11181-01	49
S610334140001	27-879843	41	S610440006004	290-931-161	85	S610485001027	6L2-11181-A2	49
S610334150001	27-66847	41	S610440006005	290-931-461	85	S610485001028	676-11181-A1	49
S610334150002	27-850318-1	41	S610440006007	290-931-160	85	S610485001029	60T-11181-00	92
S610334150003	27-879855	41	S610440006012	290-931-681	85	S610485001030	60E-11181-00	92
S610393001001	3C8-01005-4	42	S610440006015	290-931-685	85	S610485001031	686-11181-00	92
S610393001002	3F3-01005-0	42	S610440006016	290-931-687	85	S610485001032	60T-11181-10	92
S610393001003	3T9-01005-0	42	S610440006017	290-931-686	85	S610485001033	67F-11181-02-00	49
S610393003001	3C8-02305-0	43	S610440006022	420-931-728	85	S610485001034	6D3-11181-00	92
S610393003002	3F3-02305-1	43	S610440007001	420-931-130	86	S610485001036	60V-11181-00-00	49
S610393003003	3B7-02305-1	43	S610440010001	11009-3786	78	S610485001037	63D-11181-A1-00	49
S610393015001	3C8-01024-0	43	S610440010001	290-850-372	86	S610485001038	63P-11181-00	49
S610393015002	3F3-01024-0	43	S610440012002	290-850-630	86	S610485006001/1	6M6-11351-A0	93
S610393015003	3T9-01024-0	43	S610440012004	290-950-251	86	S610485006002	63M-11351-01	93

ATHENA #	OEM #	PAGE	ATHENA #	OEM #	PAGE	ATHENA #	OEM #	PAGE
S610485006003/1	6M6-11351-A2	93	S610485010040	6H4-13621-A1-00	51	S610485012036	0612 461	88
S610485006006	66E-11351-02	93	S610485010041	65L-13646-00-00	51	S610485012037	66E-41124-10	95
S610485006009	6H4-45113-A0-00	50	S610485010042	65L-13645-00-00	51	S610485012038	66V-14749-00	95
S610485006010	68F-45113-00-00	50	S610485010043	N.A.	51	S610485012039	66V-41114-00	95
S610485006012	6G1-45113-A1	50	S610485010044	N.A.	51	S610485012040	66V-41124-00	95
S610485006013	6G8-11351-A0	50	S610485010045	6G1-13621-A1	51	S610485012041	66E-14613-00	95
S610485006014	682-11351-A0	50	S610485010046	6G1-13645-A1	52	S610485012042	66E-14749-00	95
S610485006015	67C-11351-00	50	S610485010047	6G1-14198-A1	52	S610485012043	6H3-41114-A0-00	52
S610485006016	65W-11351-00	50	S610485010048	6G8-13645-00	52	S610485012044	61A-45113-A0-00	50
S610485006017	66M-11351-10	50	S610485010049	6G8-13646-A0	52	S610485012045	688-45113-00-00	50
S610485006019	60V-45113-01-00	50	S610485010050	6G8-14198-A0	52	S610485012046	6H3-45113-A0-00	50
S610485006020	63P-11351-01	50	S610485010051	6G8-15374-A0	52	S610485012047	6G5-41112-A1-00	52
S610485006021	68V-11351-00-00	50	S610485010052	6E9-14198-A0	52	S610485012048	6E5-41112-A1-00	52
S610485010001	6M6-13556-A1	78	S610485010053	676-13646-A0	52	S610485012049	6E5-41112-A1-00	52
S610485010001	6M6-13556-A1	93	S610485010056	676-13646-A0	52	S610485012050	61A-41112-A0-00	52
S610485010002	6M6-13621-A1	93	S610485010057	N.A.	52	S610485012051	6H3-41112-A0-00	52
S610485010003	6M6-13566-A1	93	S610485010058	60V-13646-00	52	S610485012052	6H4-41112-A0-00	52
S610485010004	6M6-13563-A1	93	S610485010059	60T-13556-00	94	S610485012053	6H4-41114-A0-00	53
S610485010005	6M6-13674-A1	93	S610485012001	11060-3712	78	S610485012054	68F-41114-00	53
S610485010006	6M6-13556-A1	93	S610485012002	6M6-14613-A0	94	S610485012055	676-41133-A1	53
S610485010007	6K8-13621-A1	93	S610485012003	6R7-14749-A0	94	S610485012056	676-45128-00	53
S610485010008	62T-13566-00	93	S610485012004	6R7-41114-A0	94	S610485012057	676-45127-00	53
S610485010011	63M-13674-00	93	S610485012005	6R7-14755-A0	94	S610485012058	6G1-41112-A1	53
S610485010012	63M-13556-00	93	S610485012006	6M6-14739-A1	94	S610485012059	6G1-41114-A0	53
S610485010013	63M-13566-00	93	S610485012010	61T-45113-A0	94	S610485012060	6G1-41133-A0	53
S610485010014	65U-13674-00	93	S610485012010	61T-45113-A0	52	S610485012061	6G8-41112-02	53
S610485010015	65U-13556-00	94	S610485012011	6K8-41124-A1	94	S610485012062	6G8-41114-00	53
S610485010017	39X-13621-01	94	S610485012011	6K8-41122-A1	52	S610485012063	62Y-41133-00	53
S610485010018	64X-13674-00	94	S610485012012	6K8-41122-A1	94	S610485012064	67C-41133-00	53
S610485010019	64X-13556-00	94	S610485012013	6K8-41114-A1	94	S610485012065	62Y-41134-01	53
S610485010020	66V-13556-00	94	S610485012014	6K8-41112-A1	94	S610485012066	67C-45123-00	53
S610485010021	66E-13556-00	94	S610485012015	6K8-14739-A1	94	S610485012067	682-41112-A1	53
S610485010026	61A-13646-00-00	51	S610485012016	6K8-14749-00	94	S610485012068	66M-41133-00	53
S610485010027	64E-13645-A0-00	51	S610485012017	6K8-14755-A1	94	S610485012069	67C-41114-00	53
S610485010028	6K7-13645-A1-00	51	S610485012019	62T-14613-00	95	S610485012070	65W-41114-00	53
S610485010029	6K7-13646-A1-00	51	S610485012022	62T-41114-01	95	S610485012071	6H4-41134-A0	53
S610485010030	6E5-13645-A1-00	51	S610485012024	63M-14613-00	95	S610485012072	63D-45123-00	53
S610485010031	688-13621-A1-00	51	S610485012025	63M-14749-00	95	S610485012073	66M-41114-01	54
S610485010032	6G5-13645-A1-00	51	S610485012026	63M-14739-00	95	S610485012074	6L2-41134-00	54
S610485010033	6H3-14198-01-00	51	S610485012027	63M-41122-00	95	S610485012075	66A-41134-A0	54
S610485010034	61A-13645-00-00	51	S610485012028	63M-41114-00	95	S610485012076	6L2-41112-A2	54
S610485010035	6E5-13621-A1-00	51	S610485012029	65U-14613-00	95	S610485012077	6L2-41114-A1	54
S610485010036	687-13621-00-00	51	S610485012032	64X-41124-00	95	S610485012078	6L2-41133-A2	54
S610485010037	61A-13621-A0-00	51	S610485012033	64X-14623-00	95	S610485012079	6E9-41114-A0	54
S610485010038	6H3-13622-00-00	51	S610485012034	66V-14613-01	95	S610485012080	676-41112-A0	54
S610485010039	6G5-11382-A1-00	51	S610485012035	66V-11193-01	95	S610485012082	60E-14613-00	95

CROSS REFERENCE LIST

CROSS REFERENCE LIST

CUSTOMER SERVICE - SERVIZIO CLIENTI: info@athena-ad.com

CUSTOMER SERVICE - SERVIZIO CLIENTI: info@athena-ad.com

ATHENA #	OEM #	PAGE	ATHENA #	OEM #	PAGE	ATHENA #	OEM #	PAGE
S610485012084	6D3-14613-00	95	S610485021030	65W-45128-00	55	S610485026003	67C-15312-00	58
S610485012085	6D3-14739-00	96	S610485021031	62Y-45127-00	56	S610485026004	686-13557-00	96
S610485012086	60E-14749-01	96	S610485021032	682-12414-A1	56	S610485026006	63P-15312-00	58
S610485012087	60E-14739-01	96	S610485021033	682-45113-A1	56	S610485051001	686-13563-01	96
S610485012090	60V-41112-00	54	S610485021035	63V-45315-A0	56	S610485108001	6R8-13116-A0	96
S610485015002	63M-11193-00	96	S610485021036	66M-45113-00	56	S610485108002	66E-14398-00	96
S610485015004	61A-11193-A1-00	54	S610485021037	66M-45128-00	56	S610485108003	N.A.	58
S610485015005	6G5-11193-A0-00	54	S610485021038	66M-41138-00	56	S610485108010	4FM-12213-00	96
S610485015006	688-11193-01-00	54	S610485021039	66M-45115-00	56	S610485150001	6G8-12414-A0	58
S610485015007	6H3-11193-00-00	54	S610485021040	62Y-12414-00	56	S610510001001	3008 436	88
S610485015008	68F-11193-01	54	S610485021041	67C-11356-00	56	S610510001002	3008 635	88
S610485015009	61T-11193-A1	54	S610485021042	65W-11169-00	56	S610510006001	3008 050	88
S610485015010	6L2-11193-A1	54	S610485021043	65W-11356-00	56	S610510006002	3008 411	88
S610485015011	6L2-13621-00	54	S610485021044	65W-14457-10	56	S610510010002	3008 076	88
S610485015012	6E9-11193-A0	54	S610485021045	648-13621-A1	56	S610510012001	3008 080	88
S610485015013	60E-11193-00	96	S610485021046	648-13645-A0	56	S610510012002	3008 081	88
S610485017002	6M6-81365-A0	96	S610485021047	655-12414-A1	56	S610510012003	3008 434	88
S610485017003	66V-81168-10	96	S610485021050	63D-45114-A0	56	S610510012006	0612 914	88
S610485018001	6K8-15369-A1	96	S610485021051	6H3-45127-00	56	S610510012008	3008 082	88
S610485021001	655-12414-00	96	S610485021052	66M-13645-00	56	S610510021001	3008 058	88
S610485021002	6K8-13674-A1	96	S610485021053	66M-13646-00	56	S610510047001	17691 98E30	88
S610485021002	6K8-13674-A1	96	S610485021054	66M-11356-00	57	S610510093004	0673 090	88
S610485021004	63M-81365-00	96	S610485021055	66M-11357-00	57	S61334021031	N.A	9
S610485021006	66E-1131B-01	96	S610485021057	90430-12072	57	S710337001001	N.A.	60
S610485021007	66E-14623-00	96	S610485021058	6L2-45315-A0	57	S710337001002	3853336, 908611	64
S610485021008	61A-12414-00-00	54	S610485021059	6L2-45113-A2	57	S710337001002	913274, 914812	64
S610485021009	6G5-14483-A1-00	54	S610485021060	6L2-14198-00	57	S710337001002	688-11181-A1	60
S610485021010	6E5-11381-A1-00	55	S610485021061	676-45114-A1	57	S710337001003	311210	64
S610485021011	6G5-14416-A1-00	55	S610485021062	6F5-45113-A0	57	S710337001003	27-34273	60
S610485021012	688-12414-A1-00	55	S610485021063	6G1-45315-A0	57	S710337001004	841207-4, 856474-2	64
S610485021013	650-24431-00-00	55	S610485021066	67C-45123-00	57	S710337001004	27-75611	60
S610485021014	6E5-14198-A1-00	55	S610485024001	63M-13116-00	96	S710337001005	3854299, 912227	64
S610485021015	61A-11381-A0-00	55	S610485024002	6E5-11193-A0-00	57	S710337001005	914930, 910833	64
S610485021016	6E5-14483-A1-00	55	S610485024003	6E5-11381-A1-00	57	S710337001005	27-11986	60
S610485021017	6H3-12414-A1-00	55	S610485024004	68F-11381-00	57	S710337010001	24-11977	61
S610485021018	6H4-11193-A1-00	55	S610485024005	676-44324-A0	57	S710337012002	27-99777-2	61
S610485021019	6H4-14198-00-00	55	S610485024006	676-44315-A1	57	S710337012003	27-96428	61
S610485021020	630-11193-A0-00	55	S610485024007	679-44316-A0	57	S710337012004	27-53354	61
S610485021021	6H4-15369-A1-00	55	S610485024008	6L2-44367-00	57	S710337012006	27-52546	61
S610485021022	N.A.	55	S610485024009	63D-44316-00	57	S710337012007	27-824236	61
S610485021023	6H4-14198-01	55	S610485024014	63D-44316-00	57	S710337015001	27-13865-1	61
S610485021024	6H3-14457-01	55	S610485024015	66M-13329-10	57	S710337015002	27-49936	61
S610485021026	679-45315-A0	55	S610485024017	6E9-12414-A1	58	S710337015003	27-949962	63
S610485021027	337068	55	S610485024018	6G1-44315-A0	58	S710337015004	27-35996	63
S610485021028	62Y-13475-00	55	S610485026001	62Y-15312-00	58	S710337021001	27-52457-2	61
S610485021029	61N-45315-00	55	S610485026002	67C-45113-00	58	S710337021002	27-41610	61

ATHENA #	OEM #	PAGE	ATHENA #	OEM #	PAGE	ATHENA #	OEM #	PAGE
S710337021003	27-70143-1	61	S71060001005	129171-01330	67	S710600024002	124223-42110	70
S710337021004	27-142147	61	S71060001006	129002-01331	67	S710600024004	121000-42051	70
S710337021005	N.A.	61	S71060001007	129553-01350	67	S710600024005	N.A.	70
S710337021006	N.A.	61	S71060001008	129573-01351	67	S710600024006	N.A.	70
S710337021009	N.A.	61	S71060001009	119174-01340	67	S710600026001	128170-01750	70
S710337021010	N.A.	61	S71060006001	N.A.	68	S710600026002	124000-01751	70
S710337021011	N.A.	61	S71060007001	128170-01510	68	S710600026003	121000-01751	70
S710337021013	27-48043-1	61	S71060007002	121575-01510	68	S710600026004	129198-01750	70
S710337021014	27-73814	61	S710600012001	N.A.	68	S710600026005	129400-01750	70
S710337021015	27-34208	61	S710600021001	128170-11310	68	S710600086001	121400-01850	70
S710337021016	27-34209	62	S710600021002	128170-03070	68	S710600108001	124160-34845	70
S710337024001	27-34897	62	S710600021003	128170-42090	68	S710600150001	N.A.	70
S710337024002	27-49110	62	S710600021004	104211-49160	68	S710600154001	43400-500390	70
S710337024003	N.A.	62	S710600021005	128270-11310	68	S710600154002	43400-500450	70
S710337024004	27-33956	62	S710600021006	N.A.	68	S710600154003	43400-500570	70
S710337026001	27-883964	62	S710600021007	N.A.	68			
S710337026002	N.A.	62	S710600021008	N.A.	68			
S710337026003	N.A.	62	S710600021009	N.A.	68			
S710337026004	N.A.	62	S710600021010	N.A.	68			
S710337026005	N.A.	62	S710600021011	N.A.	68			
S710337049001	N.A.	62	S710600021012	128370-13181	68			
S710337049002	27-34486-3	62	S710600021013	N.A.	68			
S710337049003	27-87707	62	S710600021014	N.A.	68			
S710337078001	27-14250	62	S710600021015	N.A.	68			
S710337078002	27-49953	62	S710600021016	N.A.	68			
S710337078003	27-81572	62	S710600021017	N.A.	69			
S710337078004	N.A.	62	S710600021018	N.A.	69			
S710337078005	N.A.	62	S710600021019	N.A.	69			
S710337086001	27-34213	62	S710600021020	N.A.	69			
S710337086003	N.A.	62	S710600021021	N.A.	69			
S710337150001	27-41812	62	S710600021022	N.A.	69			
S710337150002	N.A.	63	S710600021023	N.A.	69			
S710337150003	27-33179-2	63	S710600021024	N.A.	69			
S710337150004	27-53045-1	63	S710600021025	N.A.	69			
S710337150005	N.A.	63	S710600021026	N.A.	69			
S710337150006	27-47590-1	63	S710600021027	N.A.	69			
S710337150007	N.A.	63	S710600021028	N.A.	69			
S710530001001	859134	64	S710600021029	N.A.	69			
S710530001001	835909	64	S710600021030	N.A.	69			
S710530012001	N.A.	64	S710600021031	N.A.	69			
S710530012002	N.A.	64	S710600021032	N.A.	69			
S710530012003	N.A.	64	S710600021033	N.A.	69			
S710600001001	128170-01331	67	S710600021034	N.A.	69			
S710600001002	128171-01911	67	S710600021035	N.A.	69			
S710600001003	128271-01911	67	S710600021036	N.A.	69			
S710600001004	128374-01911	67	S710600024001	128170-32030	70			

CROSS REFERENCE LIST

CROSS REFERENCE LIST

CROSS REFERENCE LIST

CROSS REFERENCE LIST

OEM #	ATHENA #	PAGE	OEM #	ATHENA #	PAGE	OEM #	ATHENA #	PAGE
	P60039340001	42		P600250850600	74		P600485600601	90
	P600393850001	42		P600250850700	74		P600485600602	90
	P600393850002	42		P600250850702	74		P600485600603	90
	P600393850003	42		P600250850900	74		P600485600604	90
	S610393047001	43		P600427600004	79		P600485600605	90
	S610393058001	43		P600427600005	79		P600485600606	90
	S610393058002	43		P600427600006	79		P600485600900	90
	S610393108001	43		P600427600009	79		P600485850027	90
	S610393108002	43		P600427850001	79		P600485850028	91
	P700600850001	66		P600427850002	79		P600485850029	91
	P700600850002	66		P600427850003	80		P600485850032	91
	P700600850003	66		P600427850004	80		P600485850033	91
	P700600850004	66		P600427850005	80		P600485850500	91
	P700600850005	66		P600427850006	80		P600485850601	91
	P700600850006	66		P600427850007	80		P600485850602	91
	P700600850007	66		P600427850008	80		P600485850604	91
	P700600850008	66		P600427850009	80		P600485850605	91
	P700600850009	66		S610427010001	81		P600485850606	91
	P700600850010	66		S610427021006	81		P600485850900	91
	P600250400001	72		S610427108003	81	14479	S610334024011	37
	P600250400004	72		P600440400001	83	64877	S610334024012	37
	P6002504000900	72		P600440400650	83	303355	S610245117001	21
	P600250600001	72		P600440400720	83	303615	S610245108001	21
	P600250600004	72		P600440400800	83	304762	S610245012016	18
	P600250600005	72		P600440600500	83	304784	S610245021032	20
	P600250600260	72		P600440600501	83	307069	S610245001018	15
	P600250600300	72		P600440600650	83	307133	S610245012008	18
	P600250600400	72		P600440600720	83	307133	S610245021005	19
	P600250600401	72		P600440600800	83	310058	S610245150001	21
	P600250600500	73		P600440850001	83	311210	S710337001003	64
	P600250600502	73		P600440850002	83	311364	S610245021031	20
	P600250600600	73		P600440850003	83	311365	S610245021030	20
	P600250600700	73		P600440850500	84	313413	S610245001012	15
	P600250600900	73		P600440850501	84	313416	S610334047011	21
	P600250850001	73		P600440850650	84	313416	S610334047011	38
	P600250850002	73		P600440850700	84	315538	S610245021016	19
	P600250850003	73		P600440850701	84	317305	S610245010017	18
	P600250850004	73		P600440850720	84	317914	S610245012002	18
	P600250850005	73		P600440850800	84	317951	S610245024001	20
	P600250850006	73		P600440850951	84	317955	S610245012001	18
	P600250850300	73		P600510850001	87	318156	S610245012015	18
	P600250850400	74		P600510850002	87	318335	S610245021003	19
	P600250850401	74		P600485400602	90	318358	S610245001001	15
	P600250850500	74		P600485400603	90	318373	S610245006010	16
	P600250850501	74		P600485600032	90	318609	S610245021022	20
	P600250850502	74		P600485600500	90	318924	S610245021025	20

OEM #	ATHENA #	PAGE	OEM #	ATHENA #	PAGE	OEM #	ATHENA #	PAGE
318925	S610245047001	20	328623	S610245001014	15	337068	S610245021029	20
319174	S610245010002	17	328826	S610334010007	21	337068	S610485021027	55
319174	S610245021002	19	329103	S610245001020	15	338222	S610245001021	15
319332	S610245047002	20	329419	S610245001010	15	338484	S610245024004	20
319348	S610245012017	19	329786	S610245001022	15	339601	S610245012007	17
319661	S610245021014	19	329828	S610245006006	16	339601	S610245012006	18
319771	S610245021004	19	329830	S610245150002	21	340115	S610334001003	16
320679	S610245021009	19	329833	S610245012012	18	342291	S610245021015	19
321028	S610245024002	20	329836	S610245001005	15	344335	S610245010015	18
321182	S610245012004	18	329920	S610245021023	20	344472	S610334021013	21
321183	S610245140002	21	329975	S610245006001	16	344472	S610334021013	33
321184	S610245021006	19	330412	S610245021018	19	344526	S610245010006	17
321435	S610245012005	18	330621	S610245006002	16	346007	S610245001011	15
321479	S610245021008	19	330818	S610245001013	15	347205	S610245006011	16
321497	S610245021010	19	331101	S610245021017	19	388602	P600245850022	14
321573	S610334021016	21	331211	S610245001015	15	390078	P600245850008	13
321573	S610334021016	33	331363	S610245093007	21	390700	P600245850021	14
321722	S610245140001	21	331532	S610245010004	17	391988	P600245850002	13
321727	S610245015001	17	331598	S610245021012	19	392615	P600245850012	13
321794	S610245021020	20	331916	S610245012011	18	393433	P600245850003	13
321907	S610245010001	17	331917	S610245012010	18	394546	P600245850013	14
322332	S610245001023	15	332010	S610245001017	15	396750	P600245850014	14
322858	S610245024003	20	332108	S610334047010	21	398047	P600245850009	13
323222	S610245015003	19	332108	S610334047010	38	398172	P600245850023	14
323338	S610245021011	19	332266	S610245010018	18	398355	P600245850027	14
323459	S610334012008	32	332319	S610245021019	20	398693	P600245850026	14
323469	S610245012003	18	332369	S610245021001	19	432570	P600245850006	13
324323	S610245021007	19	333008	S610245021021	20	434381	P600245850015	14
324717	S610245006009	16	333554	S610245001009	15	436891	P600245850011	13
325092	S610245093002	21	333879	S610245006007	16	436891	P600245850019	14
325092	S610334108001	21	334726	S610245001007	15	437155	P600245850005	13
325092	S610334108001	41	335359	S610245001003	15	437725	P600245850024	14
325211	S610245012009	18	335360	S610245001002	15	437779	P600245850004	13
325260	S610245021024	20	335403	S610245010011	17	439085	P600245850001	13
325273	S610245001019	15	335404	S610245010013	18	439202	P600245850007	13
325721	S610245006008	16	335503	S610245015002	17	769525	S610334021002	33
326234	S610245021013	19	335633	S610245010005	17	835909	S710530001001	64
326468	S610245006003	16	335818	S610245010012	17	859134	S710530001001	64
326926	S610245010016	18	335819	S610245010014	18	3082937	S510427108001	81
327674	S610334024001	21	336226	S610245010008	17	3240045	S610427021002	81
327674	S610334024001	37	336227	S610245010007	17	3240055	S610427006002	81
327707	S610245093001	20	336361	S610245001016	15	3240191	S610427001001	80
328590	S610245006004	16	336388	S610245010010	17	3240213	S610427001002	80
328604	S610245021026	20	336389	S610245010009	17	3240251	S610427001003	80
328618	S610245006005	16	336429	S610245012014	18	5000400	P600245850010	13
328622	S610245010003	17	336430	S610245012013	18	5211489	S610427012003	81

OEM #	ATHENA #	PAGE	OEM #	ATHENA #	PAGE	OEM #	ATHENA #	PAGE
5211623	S610427012005	81	11060-3716	S610250108002	78	128170-01750	S710600026001	70
5811045	S610427012002	81	11060-3717	S610250010005	76	128170-03070	S710600021002	68
5811057	S610427006001	81	11060-3718	S610250012026	77	128170-11310	S710600021001	68
5811145	S610427021001	81	11060-3721	S610250012004	76	128170-32030	S710600024001	70
5811784	S610427006004	81	11060-3723	S610250021004	78	128170-42090	S710600021003	68
5830038	S610427012004	81	11060-3726	S610250012007	76	128171-01911	S710600001002	67
5830051	S610427012001	81	11060-3727	S610250012008	76	128270-11310	S710600021005	68
5830061	S610427108002	81	11060-3728	S610250012006	76	128271-01911	S710600001003	67
5830062	S610427108001	81	11060-3730	S610250012005	76	128370-13181	S710600021012	68
N.A.	S610334047033	39	11060-3732	S610250012024	77	128374-01911	S710600001004	67
0612 461	S610485012036	88	11060-3744	S610250021003	78	129002-01331	S710600001006	67
0612 914	S610510012006	88	11060-3754	S610250012021	77	129171-01330	S710600001005	67
0673 090	S610510093004	88	11060-3756	S610250012020	77	129198-01750	S710600026004	70
104211-49160	S710600021004	68	11060-3757	S610250012022	77	129400-01750	S710600026005	70
11004-3008	S610250001006	75	11060-3759	S610250012003	76	129553-01350	S710600001007	67
11004-3019	S610250001005	74	11060-3760	S610250006008	75	129573-01351	S710600001008	67
11004-3703	S610250001007	75	11060-3761	S610250093003	78	16062-510	S610250010001	76
11004-3706	S610250001009	75	11060-3767	S610250012027	77	17691 98E30	S610510047001	88
11004-3708	S610250001003	74	11060-3768	S610250012043	77	24-11977	S710337010001	61
11004-3709	S610250001001	74	11060-3769	S610250012023	77	25-818573	S610334001022	28
11004-3713	S610250001010	75	11060-3776	S610250108005	78	25-884391	S610334001023	28
11004-3714	S610250001014	75	11060-3783	S610250006007	75	27-11338	S610334047002	37
11004-3715	S610250001013	75	11060-3784	S610250093002	78	27-11338A88	P600334850015	25
11004-3716	S610250001004	74	11060-3785	S610250012036	77	27-11977A88	P700337999006	59
11004-3717	S610250001012	75	11060-3786	S610250012037	77	27-11986	S710337001005	60
11004-3720	S610250001015	75	11061-0090	S410250015053	78	27-12775-4	S610334010021	31
11004-3721	S610250001020	75	11061-3708	S610250006009	75	27-12775-5	S610334047040	39
11004-3722	S610250001019	75	11061-3709	S610250017002	78	27-134612	S610334010006	30
11009-2446	S610250012010	76	11061-3710	S610250026001	78	27-13461A99	P600334850005	25
11009-3706	S610250006004	75	11061-3713	S610250012028	77	27-13865-1	S710337015001	61
11009-3708	S610250012016	77	11061-3714	S610250012029	77	27-142147	S710337021004	61
11009-3711	S610250006002	75	11061-3737	S610250010010	76	27-14250	S710337078001	62
11009-3722	S610250012013	76	11061-3738	S610250010008	76	27-14621	S610334047025	39
11009-3723	S610250012014	77	11061-3742	S610250012049	78	27-146972	S610334047004	38
11009-3744	S610250012018	77	11061-3760	S610250012047	77	27-146973	S610334047039	39
11009-3750	S610250012017	77	11061-3762	S610250012048	77	27-14697A87	P600334850041	27
11009-3752	S610250006005	75	119174-01340	S710600001009	67	27-16737-1	S610334010001	30
11009-3777	S610250012009	76	121000-01751	S710600026003	70	27-16737-1	S610334047001	37
11009-3778	S610250012011	76	121000-42051	S710600024004	70	27-18143-2	S610334093008	41
11009-3779	S610250021001	78	121400-01850	S710600086001	70	27-18307-1	S610334012002	31
11009-3782	S610250006001	75	121575-01510	S710600007002	68	27-18785-1	S610334001011	28
11009-3786	S610440010001	78	124000-01751	S710600026002	70	27-18786-1	S610334001015	28
11009-3788	S610250012012	76	124160-34845	S710600108001	70	27-19206-1	S610334024010	37
11060-3703	S610250010002	76	124223-42110	S710600024002	70	27-27936-1	S610334010013	31
11060-3712	S610485012001	78	128170-01331	S710600001001	67	27-32769	S610334024008	37
11060-3716	S610250010007	76	128170-01510	S710600007001	68	27-32770	S610334024009	37

OEM #	ATHENA #	PAGE	OEM #	ATHENA #	PAGE	OEM #	ATHENA #	PAGE
27-33179-2	S710337150003	63	27-55279-1	S610334010023	31	27-809122A2	P600334850023	6
27-33395	S610334012016	32	27-60317	S610334006016	29	27-809125A2	P600334850026	6
27-33956	S710337024004	62	27-62680-1	S610334006023	29	27-809469A2	P600334850025	6
27-34208	S710337021015	61	27-64859	S610334021050	35	27-809746A1	P600334850020	6
27-34209	S710337021016	62	27-64941	S610334010019	31	27-809748A1	P600334850002	6
27-34213	S710337086001	62	27-65744-3	S610334010007	30	27-809748A1	P600334850024	6
27-34213A2	P700337850001	59	27-657442	S610334010008	21	27-809750A1	P600334850003	6
27-34213A2	P700337999002	59	27-657442	S610334010008	30	27-809751A1	P600334850019	6
27-34273	S710337001003	60	27-657442	S610334010017	31	27-809755A1	P600334850013	6
27-34486-3	S710337049002	62	27-65788	S610334021083	37	27-809817A1	P600334850027	6
27-34897	S710337024001	62	27-66847	S610334150001	41	27-812775	S610334012006	32
27-35996	S710337015004	63	27-672741	S610334021018	34	27-812775-1	S610334012007	32
27-35996A1	P700337999010	60	27-67751-1	S610334093001	40	27-812861-1	S610334021024	34
27-38501-1	S610334021020	34	27-69238-1	S610334006013	29	27-812867-2	S610334021046	35
27-41245-1	S610334001021	28	27-69524-2	S610334012011	32	27-812867A91	P600334850009	25
27-41246-1	S610245001004	28	27-69524A75	P600334850010	25	27-812868	S610334010009	31
27-41417-2	S610334021063	36	27-69525-2	S610334012010	32	27-81359	S610334047003	37
27-41418-1	S610334021062	36	27-70143-1	S710337021003	61	27-813932-2	S610334006011	29
27-41475-8	S610334047024	39	27-70335-1	S610334021028	34	27-814195A93	P600334850006	25
27-41499-1	S610334047023	38	27-72142-1	S610334021043	35	27-814195A97	P600334850037	27
27-41499-5	S610334047020	38	27-72486A32	P600334850012	25	27-814658-1	S610334001009	28
27-41499A88	P600334850014	25	27-73377-1	S610334108009	41	27-814658-75	S610334001010	28
27-41610	S710337021002	61	27-73645	S610334010020	31	27-814658A98	P600334850044	27
27-41670-3	S610334001016	28	27-73645	S610334021019	34	27-814754	S610334047037	39
27-41812	S710337150001	62	27-73645A87	P600334850011	25	27-81475A00	P600334850030	26
27-41813	S610334012018	32	27-73665	S610334021052	35	27-814895-1	S610334010011	31
27-43004-7	S610334012004	31	27-73814	S710337021014	61	27-81572	S710337078003	62
27-43004A99	P600334850004	25	27-75611	S710337001004	60	27-815791A92	P600334999001	25
27-43005-7	S610334021009	33	27-75789	S610334047029	39	27-819023 1	S610334012029	8
27-43006-2	S610334021010	33	27-75791-1	S610334108007	41	27-819024-2	S610334021008	8
27-430073	S610334006002	29	27-75909	S610334006029	29	27-819024-2	S610334021008	33
27-43337-4	S610334006021	29	27-75909	S610334012026	30	27-819049-3	S610334006027	7
27-43777-2	S610334021017	34	27-76636	S610334021084	37	27-819113	S610334010012	8
27-43779-2	S610334021015	33	27-76862-1	S610334021069	36	27-819114-1	S610334010014	8
27-43779-2	S610334021068	36	27-76952	S610334021054	35	27-8191141	S610334010014	31
27-44328-4	S610334021012	33	27-77417	S610334024006	37	27-819133	S610334010012	31
27-47590-1	S710337150006	63	27-78028A78	P600334850016	26	27-819381	S610334006001	7
27-48043-1	S710337021013	61	27-78246-1	S610334021080	36	27-819381-4	S610334012009	7
27-48164-1	S610334108006	41	27-78690	S610334021001	33	27-819733	S610334093005	40
27-49110	S710337024002	62	27-795831	S610334001006	28	27-820438	S610334001001	7
27-49936	S710337015002	61	27-79583A9	P600334850031	26	27-820490	S610334024002	37
27-49953	S710337078002	62	27-79650-1	S610334006003	29	27-82059A1	P600334850025	6
27-52457-2	S710337021001	61	27-79797-1	S610334108008	41	27-820724A2	P600334850022	6
27-52546	S710337012006	61	27-804680	S610334010027	31	27-820725A1	P600334850024	6
27-53045-1	S710337150004	63	27-804852A1	P600334850033	26	27-820751A2	P600334850021	6
27-53354	S710337012004	61	27-804985A1	P600334850040	27	27-821370	S610334010026	31

OEM #	ATHENA #	PAGE	OEM #	ATHENA #	PAGE	OEM #	ATHENA #	PAGE
27-822420A94	P600334850028	26	27-85653-1	S610334021044	35	27-993163	S610334047028	39
27-822844-1	S610334001007	28	27-85653A87	P600334850008	25	27-99757	S610334012017	32
27-82314-2	S610334006022	29	27-856542-1	S610334006010	29	27-99777-2	S710337012002	61
27-824236	S710337012007	61	27-858081	S610334001020	28	27-999177	S610334012022	32
27-824615	S610334001002	7	27-87105-1	S610334012020	32	27-F178168-1	S610334093006	9
27-825815	S610334021023	34	27-87707	S710337049003	62	27-F178168-1	S610334093006	40
27-826549	S610334006005	7	27-879840	S610334010025	31	27-F307279-2	S610334006007	7
27-826738	S610334006004	29	27-879843	S610334140001	41	27-F372154-1	S610334047008	9
27-82687-1	S610334006006	7	27-879855	S610334150003	41	27-F372154-1	S610334047008	38
27-82687-1	S610334006005	29	27-879855A04	P600334850029	26	27-F40154-4	S610334021032	9
27-827284	S610334021081	36	27-88004	S610334093007	41	27-F40154-4	S610334021032	34
27-828292	S610334021025	34	27-880122	S610334010024	31	27-F40223	S610334047005	9
27-828553	S610334006015	29	27-880738	S610334021082	37	27-F40223	S610334047005	38
27-832933-5	S610334006028	29	27-883298A1	P600334850035	26	27-F40279-1	S610334047019	9
27-832933-5	S610334012017	30	27-883964	S710337026001	62	27-F40279-1	S610334047019	38
27-832934A00	P600334850038	27	27-88449A32	P600334850017	26	27-F406406	S610334010003	8
27-832934A00	P600334850039	27	27-88451-1	S610334006017	29	27-F406406	S610334010003	30
27-834828	S610334047041	39	27-885214A1	P600334850045	27	27-F476067	S610334093003	40
27-840484	S610334047038	39	27-887810011	S610334006025	29	27-F481836	S610334047007	9
27-841220A03	P600334850043	27	27-887810A04	P600334850042	27	27-F658529	S610334001014	7
27-847525-1	S610334047027	39	27-887825	S610334021079	36	27-F684453-1	S610334006026	7
27-850282	S610334047044	39	27-887848	S610334001019	28 49	27-F686472	S610334021007	8
27-850283	S610334047042	39	27-887848-1	S610334001018	28 49	27-F686472	S610334021007	33
27-850292	S610334047043	39	27-887893	S610334021078	36	27-F844725	S610334010005	30
27-850318-1	S610334150002	41	27-88907	S610334021038	35	27-F84748-3	S610334010004	8
27-850396A1	P600334850032	26	27-889439A01	P600334850046	27	27-F84748-3	S610334010004	30
27-85087	S610334021061	36	27-89221-1	S610334093002	40	27-F85154-1	S610334021003	8
27-852520-3	S610334001012	28	27-89221A80	P600334850034	26	27-F85154-1	S610334021003	33
27-85487	S610334021022	34	27-892319001	S610334006024	29	27-F85154-4	S610334021004	8
27-85488-2	S610334021070	36	27-892320	S610334021077	36	27-F85154-4	S610334021004	33
27-85489-2	S610334021071	36	27-90430	S610334021034	34	27-F85159-1	S610334010002	8
27-85490-2	S610334021072	36	27-90484-1	S610334021039	35	27-F85159-1	S610334010002	30
27-85491-3	S610334012012	32	27-90484A88	P600334850007	25	27-F85168-2	S610334093004	40
27-85491A90	P600334850018	26	27-93536	S610334010018	31	27-F85472-2	S610334021006	8
27-85492-2	S610334012013	32	27-949962	S710337015003	63	27-F85472-2	S610334021006	33
27-854922	S610334012025	32	27-94996Q2	P700337999009	60	27-F85748-2	S610334021005	8
27-85493	S610334047015	38	27-95185-3	S610334021042	35	27-F85748-2	S610334021005	33
27-85496-1	S610334021053	35	27-96171-1	S610334047014	38	27-F85762	S610334108002	9
27-85497-2	S610334012024	32	27-96278	S610334021040	35	27-F93472-1	S610334021029	8
27-85498-1	S610334021051	35	27-96428	S710337012003	61	27-F93472-1	S610334021029	34
27-855874	S610334012030	33	27-96542-1	S610334001005	28	27-F97067	S610334021033	9
27-85608-1	S610334024013	37	27-96761	S610334047030	39	27-F97067	S610334021033	34
27-85609-1	S610334024004	37	27-98769-1	S610334108004	41	270-500-384	S610440108003	86
27-85610-1	S610334024005	37	27-99173-2	S610334012003	31	27F476529-4	S610334001002	7
27-856452	S610334021085	37	27-99176-1	S610334012001	29	29-818574	S610334015006	33
27-856452-1	S610334021036	34	27-99176-1	S610334006012	29	290-250-080	S610440012009	86

OEM #	ATHENA #	PAGE	OEM #	ATHENA #	PAGE	OEM #	ATHENA #	PAGE
290-830-905	S610440108001	86	3T9-0103208	S610393150001	43	62Y-15312-00	S610485026001	58
290-831-615	S610440021001	86	3T9-02104-0	S610393082003	43	62Y-41133-00	S610485012063	53
290-850-040	S510440001003	84	420-931-130	S610440007001	86	62Y-41134-01	S610485012065	53
290-850-045	S610440001001	84	420-931-481	S610440012006	86	62Y-45127-00	S610485021031	56
290-850-372	S610440010001	86	420-931-503	S610440012007	86	630-11193-A0-00	S610485021020	55
290-850-605	S610440017001	86	420-931-706	S610440001004	85	63D-11181-A1-00	S610485001037	49
290-850-630	S610440012002	86	420-931-728	S610440006022	85	63D-44316-00	S610485024009	57
290-931-160	S610440006007	85	43400-500390	S710600154001	70	63D-44316-00	S610485024014	57
290-931-161	S610440006004	85	43400-500450	S710600154002	70	63D-45114-A0	S610485021050	56
290-931-401	S610440006003	85	43400-500570	S710600154003	70	63D-45123-00	S610485012072	53
290-931-420	S610440001002	84	4FM-12213-00	S610485108010	96	63D-W0001-00-00	P600485850020	47
290-931-461	S610440006005	85	60E-11181-00	S610485001030	92	63D-W0001-20-00	P600485850018	47
290-931-470	S610440021003	86	60E-11193-00	S610485015013	96	63F-11181-00	S610485001020	48
290-931-540	S610440021002	86	60E-14613-00	S610485012082	95	63M-11181-01	S610485001007	92
290-931-68185	S610440006012	85	60E-14739-01	S610485012087	96	63M-11193-00	S610485015002	96
290-931-685	S610440006015	85	60E-14749-01	S610485012086	96	63M-11351-01	S610485006002	93
290-931-686	S610440006017	85	60T-11181-00	S610485001029	92	63M-13116-00	S610485024001	96
290-931-687	S610440006016	85	60T-11181-10	S610485001032	92	63M-13556-00	S610485010012	93
290-931-702	S610440001003	85	60T-13556-00	S610485010059	94	63M-13566-00	S610485010013	93
290-950-251	S610440012004	86	60V-11181-00-00	S610485001036	49	63M-13674-00	S610485010011	93
293-250-081	S610440012008	86	60V-13646-00	S610485010058	52	63M-14613-00	S610485012024	95
3008 050	S610510006001	88	60V-41112-00	S610485012090	54	63M-14739-00	S610485012026	95
3008 058	S610510021001	88	60V-45113-01-00	S610485006019	50	63M-14749-00	S610485012025	95
3008 076	S610510010002	88	61A-11181-00-A0	S610485001019	48	63M-41114-00	S610485012028	95
3008 080	S610510012001	88	61A-11193-A1-00	S610485015004	54	63M-41122-00	S610485012027	95
3008 081	S610510012002	88	61A-11381-A0-00	S610485021015	55	63M-81365-00	S610485021004	96
3008 082	S610510012008	88	61A-12414-00-00	S610485021008	54	63P-11181-00	S610485001038	49
3008 411	S610510006002	88	61A-13621-A0-00	S610485010037	51	63P-11351-01	S610485006020	50
3008 434	S610510012003	88	61A-13645-00-00	S610485010034	51	63P-15312-00	S610485026006	58
3008 436	S610510001001	88	61A-13646-00-00	S610485010026	51	63V-45315-A0	S610485021035	56
3008 635	S610510001002	88	61A-41112-A0-00	S610485012050	52	648-13621-A1	S610485021045	56
3853336, 908611	S710337001002	64	61A-45113-A0-00	S610485012044	50	648-13645-A0	S610485021046	56
3854299, 912227	S710337001005	64	61A-W0001-01-00	P600485850004	46	64E-13645-A0-00	S610485010027	51
39X-13621-01	S610485010017	94	61N-11181-A1	S610485001025	49	64X-11181-00	S610485001009	92
3B7-02305-1	S610393003003	43	61N-45315-00	S610485021029	55	64X-13556-00	S610485010019	94
3C8-01005-4	S610393001001	42	61N-W0001-E1-00	P600485850023	47	64X-13674-00	S610485010018	94
3C8-01024-0	S610393015001	43	61T-11193-A1	S610485015009	54	64X-14623-00	S610485012033	95
3C8-02104-0	S610393082001	43	61T-45113-A0	S610485012010	94	64X-41124-00	S610485012032	95
3C8-02305-0	S610393003001	43	61T-45113-A0	S610485012010	52	650-24431-00-00	S610485021013	55
3C8-09082-0	S610393021001	43	61T-W0001-02-00	P600485850017	47	655-12414-00	S610485021001	96
3F3-01005-0	S610393001002	42	61X-11181-A0	S610485001001	92	655-12414-A1	S610485021047	56
3F3-01024-0	S610393015002	43	62T-13566-00	S610485010008	93	65L-13645-00-00	S610485010042	51
3F3-02104-0	S610393082002	43	62T-14613-00	S610485012019	95	65L-13646-00-00	S610485010041	51
3F3-02305-1	S610393003002	43	62T-41114-01	S610485012022	95	65U-11181-01	S610485001008	92
3T9-01005-0	S610393001003	42	62Y-12414-00	S610485021040	56	65U-13556-00	S610485010015	94
3T9-01024-0	S610393015003	43	62Y-13475-00	S610485021028	55	65U-13674-00	S610485010014	93

OEM #	ATHENA #	PAGE	OEM #	ATHENA #	PAGE	OEM #	ATHENA #	PAGE
65U-14613-00	S610485012029	95	676-13646-A0	S610485010053	52	6A0-W0001-21-00	P600485850008	46
65W-11169-00	S610485021042	56	676-13646-A0	S610485010056	52	6B6-11181-00	S610485001031	92
65W-11181-30	S610485001024	48	676-41112-A0	S610485012080	54	6B6-13557-00	S610485026004	96
65W-11351-00	S610485006016	50	676-41133-A1	S610485012055	53	6B6-13563-01	S610485051001	96
65W-11356-00	S610485021043	56	676-44315-A1	S610485024006	57	6D0-W0001-00-00	P600485850031	48
65W-14457-10	S610485021044	56	676-44324-A0	S610485024005	57	6D3-11181-00	S610485001034	92
65W-41114-00	S610485012070	53	676-45114-A1	S610485021061	57	6D3-14613-00	S610485012084	95
65W-45128-00	S610485021030	55	676-45127-00	S610485012057	53	6D3-14739-00	S610485012085	96
65W-W0001-00-00	P600485850016	47	676-45128-00	S610485012056	53	6E5-11181-02-00	S610485001006	48
65W-W0001-20-00	P600485850011	46	679-44316-A0	S610485024007	57	6E5-11193-A0-00	S610485024002	57
664-41134-A0	S610485012075	54	679-45315-A0	S610485021026	55	6E5-11381-A1-00	S610485021010	55
66E-11181-00	S610485001011	92	67C-11181-01	S610485001023	48	6E5-11381-A1-00	S610485024003	57
66E-1131B-01	S610485021006	96	67C-11351-00	S610485006015	50	6E5-13621-A1-00	S610485010035	51
66E-11351-02	S610485006006	93	67C-11356-00	S610485021041	56	6E5-13645-A1-00	S610485010030	51
66E-13556-00	S610485010021	94	67C-15312-00	S610485026003	58	6E5-14198-A1-00	S610485021014	55
66E-14398-00	S610485108002	96	67C-41114-00	S610485012069	53	6E5-14483-A1-00	S610485021016	55
66E-14613-00	S610485012041	95	67C-41133-00	S610485012064	53	6E5-41112-A1-00	S610485012048	52
66E-14623-00	S610485021007	96	67C-45113-00	S610485026002	58	6E5-41112-A1-00	S610485012049	52
66E-14749-00	S610485012042	95	67C-45123-00	S610485012066	53	6E7-11181-A1	S610485001022	48
66E-41124-10	S610485012037	95	67C-45123-00	S610485021066	57	6E9-11193-A0	S610485015012	54
66M-11181-01	S610485001026	49	67C-W0001-00-00	P600485850015	47	6E9-12414-A1	S610485024017	58
66M-11351-10	S610485006017	50	67C-W0001-20-00	P600485850012	46	6E9-14198-A0	S610485010052	52
66M-11356-00	S610485021054	57	67c-w0001-20-00	P600485850021	47	6E9-41114-A0	S610485012079	54
66M-11357-00	S610485021055	57	67F-11181-02-00	S610485001033	49	6F3-W0001-A4-00	P600485850005	46
66M-13329-10	S610485024015	57	682-11351-A0	S610485006014	50	6F5-45113-A0	S610485021062	57
66M-13645-00	S610485021052	56	682-12414-A1	S610485021032	56	6G1-13621-A1	S610485010045	51
66M-13646-00	S610485021053	56	682-41112-A1	S610485012067	53	6G1-13645-A1	S610485010046	52
66M-41114-01	S610485012073	54	682-45113-A1	S610485021033	56	6G1-14198-A1	S610485010047	52
66M-41133-00	S610485012068	53	682-W001-06-00	P600485850013	47	6G1-41112-A1	S610485012058	53
66M-41138-00	S610485021038	56	687-13621-00-00	S610485010036	51	6G1-41114-A0	S610485012059	53
66M-45113-00	S610485021036	56	688-11181-A0-00	S610485001010	48	6G1-41133-A0	S610485012060	53
66M-45115-00	S610485021039	56	688-11181-A1	S710337001002	60	6G1-44315-A0	S610485024018	58
66M-45128-00	S610485021037	56	688-11193-01-00	S610485015006	54	6G1-45113-A1	S610485006012	50
66M-W0001-01-00	P600485850019	47	688-12414-A1-00	S610485021012	55	6G1-45315-A0	S610485021063	57
66M-W0001-20-00	P600485850014	47	688-13621-A1-00	S610485010031	51	6G1-W0001-A2-00	P600485850009	46
66V-11181-01	S610485001012	92	688-45113-00-00	S610485012045	50	6G1-W0001-C1-00	P600485850026	48
66V-11193-01	S610485012035	95	689-W0001-04-00	P600485850017	47	6G5-11181-A0-00	S610485001008	48
66V-13556-00	S610485010020	94	68F-11193-01	S610485015008	54	6G5-11193-A0-00	S610485015005	54
66V-14613-01	S610485012034	95	68F-11381-00	S610485024004	57	6G5-11382-A1-00	S610485010039	51
66V-14623-00	S610485001014	92	68F-41114-00	S610485012054	53	6G5-13645-A1-00	S610485010032	51
66V-14739-00	S610485001013	92	68F-45113-00-00	S610485006010	50	6G5-14416-A1-00	S610485021011	55
66V-14749-00	S610485012038	95	68F-W0001-01-00	P600485850007	46	6G5-14483-A1-00	S610485021009	54
66V-41114-00	S610485012039	95	68V-11351-00-00	S610485006021	50	6G5-41112-A1-00	S610485012047	52
66V-41124-00	S610485012040	95	697-11181-A0-00	S610485001004	48	6G5-451130-A0-00	S610334015003	50
66V-81168-10	S610485017003	96	69J-11181-03-00	S610334001019	49	6G5-W0001-03-00	P600485850003	46
676-11181-A1	S610485001028	49	69J-11182-03-00	S610334001018	49	6G8-11181-A1	S610485001021	48

OEM #	ATHENA #	PAGE	OEM #	ATHENA #	PAGE	OEM #	ATHENA #	PAGE
6G8-11351-A0	S610485006013	50	6K8-41122-A1	S610485012011	52	N.A.	S610334015002	8
6G8-12414-A0	S610485150001	58	6K8-41124-A1	S610485012011	94	N.A.	S610334021021	8
6G8-13645-00	S610485010048	52	6L2-11181-A2	S610485001027	49	N.A.	S610334021030	9
6G8-13646-A0	S610485010049	52	6L2-11193-A1	S610485015010	54	N.A.	S610334047006	9
6G8-14198-A0	S610485010050	52	6L2-13621-00	S610485015011	54	N.A.	S610334047018	9
6G8-15374-A0	S610485010051	52	6L2-14198-00	S610485021060	57	N.A.	S610334108001	9
6G8-41112-02	S610485012061	53	6L2-41112-A2	S610485012076	54	N.A.	S610334108003	9
6G8-41114-00	S610485012062	53	6L2-41114-A1	S610485012077	54	N.A.	S610334108004	9
6G8-W0001-A3-00	P600485850010	46	6L2-41133-A2	S610485012078	54	N.A.	S610245012006	16
6H1-W0001-00-00	P600485850006	46	6L2-41134-00	S610485012074	54	N.A.	P600334850036	26
6H1-W0001-A0-00	P600485850006	46	6L2-44367-00	S610485024008	57	N.A.	S610334010016	31
6H3-11181-01-00	S610485001016	48	6L2-45113-A2	S610485021059	57	N.A.	P700337850003	59
6H3-11193-00-00	S610485015007	54	6L2-45315-A0	S610485021058	57	N.A.	P700337999004	59
6H3-12414-A1-00	S610485021017	55	6L2-W0001-02-00	P600485850024	47	N.A.	P700337999005	59
6H3-13622-00-00	S610485010038	51	6L2-W0001-03-00	P600485850024	47	N.A.	P700337999007	60
6H3-14198-01-00	S610485010033	51	6L2-W0001-C3-00	P600485850022	47	N.A.	S610334006008	7
6H3-14457-01	S610485021024	55	6M6-11351-A0	S610485006001/1	93	N.A.	S610334006009	7
6H3-41112-A0-00	S610485012051	52	6M6-11351-A2	S610485006003/1	93	N.A.	P600245850020	14
6H3-41114-A0-00	S610485012043	52	6M6-13556-A1	S610485010001	78	N.A.	P600245850025	14
6H3-45113-A0-00	S610485012046	50	6M6-13556-A1	S610485010001	93	N.A.	S610245021028	20
6H3-45127-00	S610485021051	56	6M6-13556-A1	S610485010006	93	N.A.	S610245108002	21
6H3-W0001-00-00	P600485850002	46	6M6-13563-A1	S610485010004	93	N.A.	S610334006020	29
6H4-11181-00-00	S610485001018	48	6M6-13566-A1	S610485010003	93	N.A.	S610334010015	31
6H4-11193-A1-00	S610485021018	55	6M6-13621-A1	S610485010002	93	N.A.	S610334012005	32
6H4-13621-A1-00	S610485010040	51	6M6-13674-A1	S610485010005	93	N.A.	S610334012014	32
6H4-14198-00-00	S610485021019	55	6M6-14613-A0	S610485012002	94	N.A.	S610334012015	32
6H4-14198-01	S610485021023	55	6M6-14739-A1	S610485012006	94	N.A.	S610334012019	32
6H4-15369-A1-00	S610485021021	55	6M6-81365-A0	S610485017002	96	N.A.	S610334012021	32
6H4-41112-A0-00	S610485012052	52	6R6-W0001-02-00	P600485850025	48	N.A.	S610334012023	32
6H4-41114-A0-00	S610485012053	53	6R7-14749-A0	S610485012003	94	N.A.	S610334015001	33
6H4-41134-A0	S610485012071	53	6R7-14755-A0	S610485012005	94	N.A.	S610334015002	33
6H4-45113-A0-00	S610485006009	50	6R7-41114-A0	S610485012004	94	N.A.	S610334021011	33
6H4-W0001-A1-00	P600485850001	46	6R8-13116-A0	S610485108001	96	N.A.	S610334021014	33
6K7-13645-A1-00	S610485010028	51	7-691529-1	S610334001013	7	N.A.	S610334021021	34
6K7-13646-A1-00	S610485010029	51	841207-4, 856474-2	S710337001004	64	N.A.	S610334021026	34
6K8-11181-A1	S610485001003	92	858452-1	S610334001017	28	N.A.	S610334021027	34
6K8-13621-A1	S610485010007	93	90430-12072	S610485021057	57	N.A.	S610334021030	34
6K8-13674-A1	S610485021002	96	913274, 914812	S710337001002	64	N.A.	S610334021031	34
6K8-13674-A1	S610485021002	96	914930, 910833	S710337001005	64	N.A.	S610334021035	34
6K8-14739-A1	S610485012015	94	92065-515	S610250012015	77	N.A.	S610334021041	35
6K8-14749-00	S610485012016	94	N.A.	S610334012028	8	N.A.	S610334021045	35
6K8-14755-A1	S610485012017	94	N.A.	S61334021031	9	N.A.	S610334021047	35
6K8-15369-A1	S610485018001	96	N.A.	S610334010005	8	N.A.	S610334021048	35
6K8-41112-A1	S610485012014	94	N.A.	S610334010015	8	N.A.	S610334021056	35
6K8-41114-A1	S610485012013	94	N.A.	S610334010016	8	N.A.	S610334021057	35
6K8-41122-A1	S610485012012	94	N.A.	S610334015001	8	N.A.	S610334021058	35

NOTE

CROSS REFERENCE LIST

OEM #	ATHENA #	PAGE	OEM #	ATHENA #	PAGE	OEM #	ATHENA #	PAGE
N.A.	S610334021059	35	N.A.	S710337049001	62	SUB-184354	S610334047032	39
N.A.	S610334021060	36	N.A.	S710337078004	62	SUB-187803	S610334086011	40
N.A.	S610334021064	36	N.A.	S710337078005	62	SUB-187803	S610334086012	40
N.A.	S610334021065	36	N.A.	S710337086003	62	SUB-187803	S610334086013	40
N.A.	S610334021066	36	N.A.	S710337150002	63	SUB-187804	S610334086007	40
N.A.	S610334021067	36	N.A.	S710337150005	63	SUB-187804	S610334086008	40
N.A.	S610334021075	36	N.A.	S710337150007	63	SUB-187804	S610334086009	40
N.A.	S610334021076	36	N.A.	S710530012001	64	SUB-187807	S610334086005	40
N.A.	S610334024003	37	N.A.	S710530012002	64	SUB-187807	S610334086006	40
N.A.	S610334024007	37	N.A.	S710530012003	64	SUB-187808	S610334086010	40
N.A.	S610334047006	38	N.A.	S710600006001	68	SUB-187809	S610334086014	40
N.A.	S610334047007	38	N.A.	S710600012001	68	SUB-187813	S610334086001	40
N.A.	S610334047009	38	N.A.	S710600021006	68	SUB-187813	S610334086002	40
N.A.	S610334047012	38	N.A.	S710600021007	68	SUB-187813	S610334086003	40
N.A.	S610334047013	38	N.A.	S710600021008	68	SUB-187813	S610334086004	40
N.A.	S610334047016	38	N.A.	S710600021009	68			
N.A.	S610334047018	38	N.A.	S710600021010	68			
N.A.	S610334047021	38	N.A.	S710600021011	68			
N.A.	S610334047022	38	N.A.	S710600021013	68			
N.A.	S610334047031	39	N.A.	S710600021014	68			
N.A.	S610334047034	39	N.A.	S710600021015	68			
N.A.	S610334047035	39	N.A.	S710600021016	68			
N.A.	S610334047036	39	N.A.	S710600021017	69			
N.A.	S610334093009	41	N.A.	S710600021018	69			
N.A.	S610334093010	41	N.A.	S710600021019	69			
N.A.	S610334108002	41	N.A.	S710600021020	69			
N.A.	S610334108003	41	N.A.	S710600021021	69			
N.A.	S610334108005	41	N.A.	S710600021022	69			
N.A.	S610334108010	41	N.A.	S710600021023	69			
N.A.	S610334108011	41	N.A.	S710600021024	69			
N.A.	S610485010043	51	N.A.	S710600021025	69			
N.A.	S610485010044	51	N.A.	S710600021026	69			
N.A.	S610485010057	52	N.A.	S710600021027	69			
N.A.	S610485021022	55	N.A.	S710600021028	69			
N.A.	S610485108003	58	N.A.	S710600021029	69			
N.A.	S710337001001	60	N.A.	S710600021030	69			
N.A.	S710337021005	61	N.A.	S710600021031	69			
N.A.	S710337021006	61	N.A.	S710600021032	69			
N.A.	S710337021009	61	N.A.	S710600021033	69			
N.A.	S710337021010	61	N.A.	S710600021034	69			
N.A.	S710337021011	61	N.A.	S710600021035	69			
N.A.	S710337024003	62	N.A.	S710600021036	69			
N.A.	S710337026002	62	N.A.	S710600024005	70			
N.A.	S710337026003	62	N.A.	S710600024006	70			
N.A.	S710337026004	62	N.A.	S710600150001	70			
N.A.	S710337026005	62	SUB-184354	S610334047017	38			

NOTE

CUSTOMER SERVICE - SERVIZIO CLIENTI: info@athena-ad.com

CUSTOMER SERVICE - SERVIZIO CLIENTI: info@athena-ad.com

CONDIZIONI DI VENDITA

Il conferimento dell'ordine comporta l'accettazione delle nostre condizioni di vendita, qui di seguito riportate, che il committente dichiara di conoscere; eventuali modifiche, per essere valide, dovranno essere concordate precedentemente in forma scritta.

I prezzi si intendono per merce franco ns. magazzino, IVA esclusa, non sono impegnativi e possono venire modificati senza preavviso.

Le nostre fatture devono essere pagate in contanti alla consegna, al nostro domicilio di Alonte, salvo diversamente stabilito. Qualora in fattura venisse concordato un termine di pagamento, siamo autorizzati, per comodità di esazione, ad emettere una tratta o una ricevuta bancaria per il corrispondente importo alla scadenza.

Tratte, ricevute bancarie, cambiali, aperture di credito irrevocabili confermate, a copertura di fatture accettate o pagabili, anche se convenute ed emesse in luogo diverso, si intendono sempre salvo buon fine e, se non onorate alla scadenza, mantengono fermo ad ogni effetto l'obbligo del successivo pagamento delle fatture in contanti al nostro domicilio di Alonte. Procedimenti di trasmissione di valuta dall'estero verso l'Italia non comportano modifica all'obbligo del pagamento al nostro domicilio di Alonte.

Anche se riferito ad una data, il termine di consegna si intende approssimativo, salvo espresso accordo scritto dove esso diviene tassativo o essenziale. In ogni caso, Athena non è responsabile di ritardi dovuti a causa di forza maggiore, o indipendenti comunque da nostra volontà, quali incidenti, esplosioni, scioperi, disservizio postale, ferroviario, doganale, o di ogni altro mezzo di comunicazione o trasporto, rifiuti o ritardi da parte delle autorità a rilasciare licenze di importazione, esportazione o ritiro di licenze già rilasciate, difficoltà di approvvigionamento nei luoghi di produzione o altro ancora. In tutti questi casi, qualora la causa non comporti la definitiva impossibilità della fornitura, il termine di consegna, sia esso approssimativo o essenziale, si intende prorogato di una durata uguale a quella degli impedimenti che hanno causato il ritardo della fornitura.

Il mancato pagamento, anche parziale, di una fattura, oltre che l'addebito degli interessi di mora (vedi decreto legislativo 09/10/02 nr. 231), comporta l'automatica decadenza dei termini di pagamento e l'immediata esigibilità di qualsiasi fattura successiva, oltre al nostro diritto ad emettere tratta a vista per il corrispondente importo. Tutte le vendite sono effettuate con riserva di proprietà; pertanto, la proprietà dei beni venduti rimane del venditore fino al completo pagamento dell'importo dovuto.

La merce viene venduta franco magazzino di Alonte (VI) e viaggia a rischio e pericolo del compratore anche se resa franco destino. Qualunque reclamo per danni od omissioni inerenti al trasporto dovrà quindi essere fatto agli esecutori di esso. Qualsiasi tassa, imposta, dazio attuale o futuro, o aumento degli interessi a carico esclusivo del compratore.

All'arrivo della merce, il compratore è tenuto ad esaminarla ed a verificarne peso, confezione, condizioni e caratteristiche poiché trascorsi 10 giorni dal ricevimento non si accettano eventuali reclami.

In caso di reclami resta fermo l'obbligo da parte del compratore del pagamento delle fatture alla loro scadenza, compresa quella cui si riferisce il reclamo. Qualora, previo accertamento da parte dei nostri tecnici, il reclamo risulti fondato ed il compratore sia in regola coi pagamenti, il nostro obbligo si limita al rimborso del prezzo indicato in fattura o, a nostra scelta, alla sostituzione della merce difettosa o non conforme precedentemente restituita. Il compratore rinuncia a qualsiasi risarcimento di danno o rimborso spese. Non si accettano resi di merce totalmente o parzialmente lavorata.

Il presente contratto, anche se concluso all'estero, la sua formazione, interpretazione ed esecuzione si intendono regolati esclusivamente dalle leggi italiane integrati dalle norme internazionali INCOTERMS nei testi redatti in lingua italiana.

Per qualsiasi controversia inerente al presente contratto sarà esclusivamente competente l'autorità giudiziaria, in particolare il foro di Vicenza.

ATHENA S.P.A

CONDITIONS OF SALE

All our sales are subject to the following conditions of sale that rule all purchasing conditions, with the exception of formal and express derogation of the company ATHENA. All received orders are considered as accepted by ATHENA only after the issue of a written order confirmation.

Our price list is based on Ex-works terms. All goods, even if delivered free of charge, are delivered at buyer's risk and peril.

All complaints on visible faults or on the non-conformity of the received articles shall be sent in writing within eight days from receipt of goods. In case of visible faults or non-conformity duly confirmed by ATHENA, the buyer will be granted the replacement or the reimbursement of the goods, with the exclusion of any claim for indemnity, damages or interests. By way of an exception ATHENA can accept the returns of goods for any other reason only by previous written agreement, if goods are sent in their original packing without being used and delivered free of charge within 15 days after receipt. ATHENA will accept these returns of goods and issue a credit note by deducting a lump sum of 15% on the invoiced amount. All goods returned without our authorization and not respecting the condition above given, even if they are received by our company, cannot be considered as part of this agreement.

Our goods are invoiced at the prices in force at the date of order receipt and shall be payable cash. Failing the written confirmation for any particular reason not attributable to us (including fax, e-mail, etc...) our goods will be invoiced at the prices in force at the date of our order confirmation. These conditions of sale may be modified if the buyer does not update his current bank and commercial references or if these are not more acceptable. By way of penal clause and according to the provisions of the law, all amounts due at their expiry date, which are still due 4 days after the bringing of a default action, will lead to a penalty for delay in payment equal to 2 times the legal interest rate which shall be applied to the remaining amounts due. In case of delay in payment, the company ATHENA can suspend any delivery.

To benefit from the guarantee, it is essential that the goods shall be assembled by a technician who has all necessary competence and tooling. The guarantee of the products we commercialise undergoes the Italian laws DPR224 of 1988 and D.Lgs. 24 of 2002. The guarantee is restricted to the simple replacement of goods without any other compensation cannot be claimed. The guarantee cannot be applied in the following cases: usage in competitions, inobservance of the assembling instructions, wrong usage, incorrect assembling. For each request of guarantee, all pieces shall be returned free of charge to ATHENA with a covering letter explaining the reason of the problem and a copy of the invoice or consignment note. For all request of guarantee concerning pistons, the cylinder shall be included in the parcel.

Legal and beneficial ownership of the goods shall remain at ATHENA until full payment for the goods has been made. In conformity with this clause, the issue of a certificate with obligation to pay (draft or other) does not constitute the payment. The lack of payment at any of the expiries due, even if agreed, can lead to the claiming to the goods. These dispositions do not constitute an obstacle to transfer to the buyer, right from delivery, to the risks of loss and deterioration of goods as well as the damages that may occur. Right from the resale, the buyer commits himself to settle immediately to the seller the remaining amount due, all delays of payment agreed upon with the signing of the contract become, by explicit will between the parties, invalid.

Any claim or dispute arising from the sales of goods, even if in case of guarantee appeal or majority of defendants, shall fall under the exclusive jurisdiction of the Court of Commerce within the competence where our company is situated.

ATHENA S.P.A



Athena è un gruppo internazionale con **3 divisioni** e 10 stabilimenti in Italia e nel mondo.
/ **Athena** is an international group organized into 3 business divisions and 10 manufacturing plants worldwide.

1. ATHENA INDUSTRIES



athena.eu

Applicazioni e forniture per automotive, macchine agricole, industria alimentare, compressori, caldo/freddo, elettrodomestici, vetrometallo, materiali per isolamento termo/acustico,...

/ Components for the automotive industry, agriculture machines, compressors, glass-to-metal parts, heating and cooling field, thermal and acoustic insulation, household appliances and food industries.

ATHENA NOSTRALI®

3. ATHENA DISTRIBUTION



athenaevolution.com

Distribuisce per l'Italia i marchi più prestigiosi del mondo sport, fashion e fun: GoPro, Ogio, XSeries, VR46, GET Cycling.

/ Distributes for the Italian market the most prestigious brands for sports, fashion&fun world: GoPro, Ogio, XSeries, VR46, GET Cycling.



2. ATHENA MOTORPARTS



athenaparts.com

Progetta e produce, attraverso i diversi marchi del gruppo, ricambi di alta qualità per moto, scooter, maxiscooter, off road, automotive, sia per le parti meccaniche sia per quelle elettroniche.

/ Designs, manufactures and distributes products across different brands of the group high-quality spare parts for motorbikes, scooters, maxiscoters, off road, automotive, both for mechanical and electronic parts.



Athena HQ
Athena CARMAGNOLA
Athena ERCHIE
NOSTRALI
BLUETECH
Athena INDIA
VEDAMOTORS

Athena HQ

Athena HQ

